



Interim Report: WP2 “Voltage profile modeling and study” Part A and Part B

DOI:

[10.13140/RG.2.1.1298.6326](https://doi.org/10.13140/RG.2.1.1298.6326)

[Link to publication record in Manchester Research Explorer](#)

Citation for published version (APA):

Ballanti, A., Ochoa, L. F., Guo, Y., & Li, H. (2015). Interim Report: WP2 “Voltage profile modeling and study” Part A and Part B. Electricity North West Limited (ENWL) . <https://doi.org/10.13140/RG.2.1.1298.6326>

Citing this paper

Please note that where the full-text provided on Manchester Research Explorer is the Author Accepted Manuscript or Proof version this may differ from the final Published version. If citing, it is advised that you check and use the publisher's definitive version.

General rights

Copyright and moral rights for the publications made accessible in the Research Explorer are retained by the authors and/or other copyright owners and it is a condition of accessing publications that users recognise and abide by the legal requirements associated with these rights.

Takedown policy

If you believe that this document breaches copyright please refer to the University of Manchester's Takedown Procedures [<http://man.ac.uk/04Y6Bo>] or contact uml.scholarlycommunications@manchester.ac.uk providing relevant details, so we can investigate your claim.



Title: **“Interim Network Modelling and Analysis” Part A and Part B**

Synopsis: This study uses the estimated load models based on literature review and models the capability of primary substation to deliver demand response and reactive power absorption capability. The model related to primary substation to deliver demand response (*Part A*) will be validated against the measurements from the Trials. The model related to reactive power absorption capability (*Part B*) will be validated against the IPSA model used in ENWL. The key outcome of *Part A* is the analysis of the compliance with statutory limits of the network voltages at customers' premises during voltage regulation techniques. The key outcome of *Part B* is the analysis that confirms the EHV network reactive power absorption capability across ENWL's network.

Document ID: UoM-ENWL_CLASS_IR-AB_v06

Date: 24th January 2015

Prepared For: Victoria Turham
Future Networks Engineer
Electricity North West Limited, UK

Prepared By: Andrea Ballanti & Dr Luis(Nando) Ochoa (Part A)
The University of Manchester
Sackville Street, Manchester M13 9PL, UK

Yue Guo & Dr Haiyu Li (Part B)
The University of Manchester
Sackville Street, Manchester M13 9PL, UK

Contacts: Dr Luis(Nando) Ochoa Dr Haiyu Li
+44 (0)161 306 4819 +44 (0)161 306 4694
luis.ochoa@manchester.ac.uk haiyu.li@manchester.ac.uk

The results and discussions provided in this report are outcomes of preliminary analyses and 'proof of concept' performed at selected subset of substations of a particular electricity distribution network under specific operating conditions and is not guaranteed to be the same for other sites or other networks. The readers should use this document as a guidance and at their own responsibility. Any omissions or errors, if identified, should be reported to the authors.

Executive Summary – Part A

This interim report part A presents the progress of the Low Carbon Networks Fund Tier 2 project “Customer Load Active System Services (CLASS)” run by Electricity North West Limited (ENWL).

The aim of CLASS is to provide ENWL with greater understanding of the possible techniques to maximise the usefulness of their assets and potential provision of services to National Grid by actions undertaken exclusively at primary substation level. It addresses three main solutions:

1. Peak reduction at primary substations: resulting from voltage changes obtained through on load tap changer (OLTC) actions
2. Reactive power absorption: resulting from tap staggering actions
3. Provision of fast reserves and frequency response: provided by the fast tripping of one parallel transformer and OLTC actions

This interim report quantifies the benefits of first solution and its impact on the customers’ voltage. Firstly two different load modelling approaches are presented. The first, called “time-independent”, applies fixed load parameters throughout the day to the whole primary substation. The second, called “time-varying”, undertakes a bottom up approach in which each single domestic appliance load model is aggregated at the primary substation.

To illustrate an initial quantification of peak reduction both approaches have been applied on a winter day on a real primary substation (Didsbury). The demand has been assumed entirely residential with a 3% voltage reduction. Both methodologies have shown consistency especially at peak. Considering the more accurate “time-varying” approach the main findings are summarised below:

- Potential active power reduction of 3.7%, (i.e., 0.6 MW out of 16.18 MW) at peak
- Potential reactive power reduction of 7.6% (i.e., 0.31 Mvar out of 4.06 Mvar) at peak
- Varying load model parameters throughout the day

Applying the above methodology to 349 primary substations assuming a residential behaviour of demand (which is a very optimistic assumption) and coincident peaks the following outcomes have been obtained:

- A peak reduction of 143.74 MW (out of 4362 MW, 3.3 %).
- A peak reduction between 0.35 and 0.50 MW for 37% of the primary substations
- A slightly more than linear relationship (i.e., 1:1.2-1.3) between voltage and demand

Thereafter the methodology to integrate LV network constraints in the assessment of the time-varying capabilities of primary substations in the context of demand reduction is introduced. A Monte Carlo approach has been applied to 50+ LV feeders considering 200 simulations representing a winter day. The resulting BS EN 50160 percentage of non-compliant customers to different voltage values at the primary sides of the LV transformers (V_{HV}) is the main outcome. In particular:

- $V_{HV}=0.94-1$ pu → less than 1% in average of BS EN 50160 non-compliant customers
- $V_{HV}=0.91-1$ pu → less than 5% in average of BS EN 50160 non-compliant customers

Finally, one real HV network modelled in OpenDSS is used to illustrate how the voltages at the primary side of LV transformers and its relationship with BS EN 50160 complaint customers will be integrated in future HV network studies. For this specific example has been estimated that is possible to reduce the voltage at the primary substation by up to 4.38% (3 tap positions) without affecting more than 1% of the corresponding LV customers.

Further studies will be addressed to consider with more accuracy actual aggregated demand and voltage profiles by using monitoring data from the trial. The outcomes will be extended and validated considering different seasons.

Executive Summary – Part B

In the project of Work Package 2 – Part B, tasks mainly focus on accessing ENWL EHV network reactive power absorption capability to support transmission network through parallel transformers tap stagger operation technique. The studies of WP2-Part B consist of 3 aspects. (i) Network conversion and modelling, (2) State estimation and tap stage control method and (iii) Q absorption capability study.

More specifically, this report of Part B, firstly, presents the methodology to study the whole ENWL EHV distribution network reactive power absorption capability during the consideration of stagger tap operation in a pair of parallel transformers. According to the number of Grid Supply Point (GSP) from NG to ENWL networks, they can be divided as 18 sub-networks. Two representative sub-networks are selected as the initial studies. One is the south Manchester network which has the medium size sub-network with typical domestic loads and a number of distributed generators. The other is Stalybridge which has the mostly loaded network without distributed generators.

Although the whole ENWL EHV network in IPSA (Interactive Power System Analysis) model was given, it has been limited to the network power flow design and planning studies. In order to be able to incorporate the network simulation tool with the proposed stagger tap operation method, the ENWL EHV network has been converted to OpenDSS, a simulation for distribution networks, for the studies. The converted OpenDSS models are validated through comparing the voltages and power flows between IPSA and OpenDSS models under different network operating conditions.

To exam the correctness of the stagger tap operation, a matrix database/dashboard table search method was design and implemented. The method was applied to the converted South Manchester network Open DSS model. The results were examined and analysed.

Finally, the Q absorption capability of both South Manchester and Stalybridge networks under 4-stagger tap operation constraints were simulated and accessed. By applying data averaging method, the overall capability across the whole EWNL EHV distribution network has been estimated. Although even considering the maximum 4 stagger tap operation constraint to the CLASS project, some parallel transformers may be limited to 3, 2 or 1 or even 0 stagger tap operation due to their tap reference position at highest or lowest load flow conditions, respectively, the overall capability across the whole EWNL EHV distribution network should be smaller than the estimated. Conclusion is drawn to confirm the EHV network reactive power absorption capability across ENWL's network.

Table of Contents

Executive Summary – Part A	2
Executive Summary – Part B	3
1 Part A – Primary Substation Capabilities to Deliver Demand Response	5
1.1 Introduction	5
1.1.1 Report structure.....	5
1.1.2 Steady-State Load Modelling: Definitions	6
1.1.3 Literature Review on Aggregated Loads (CVR).....	6
1.2 Time-Independent Load Model.....	7
1.2.1 Load profiling.....	7
1.2.2 Peak demand reduction: Theoretical limit	8
1.2.3 Peak demand reduction: Capability assessment	8
1.2.4 Limitations of the approach	10
1.3 Time-Varying Load Model.....	10
1.3.1 Load profiling.....	10
1.3.2 Peak demand reduction: Capability assessment	12
1.4 LV Network Constraints: Initial Assessment.....	13
1.4.1 Methodology	13
1.4.2 Initial Results	14
1.4.3 Limitations of the approach	15
1.5 HV Network Time-Series Analysis.....	15
1.5.1 Daily Power Flow Analysis	16
1.5.2 Voltage Headroom Assessment.....	16
1.5.3 Limitations of the Approach.....	18
1.6 Conclusions – Part A	18
2 Part B – Primary Substation Capabilities to Deliver Reactive Power Absorption	20
2.1 Introduction	20
2.2 Methodology	21
2.3 Network Modelling Tool Selection	22
2.3.1 Sub-network selection	22
2.3.2 Network conversion.....	23
2.3.3 Testing and validation of the converted sub-networks.....	24
2.4 Matrix/Dashboard Table Based Tap Staggering Control Method.....	28
2.4.1 Introduction.....	28
2.4.2 Establishment of matrix database/dashboard look up table	29
2.4.3 Matrix database/dashboard lookup table search method	30
2.5 ENWL Network Q Absorption Capability Studies	32
2.5.1 ENWL EHV network model	32
2.5.2 ENWL reactive power absorption capability estimation	33
2.6 Conclusions - Part B.....	36
3 References.....	37
Appendix 1 South Manchester Network from ENW.....	38
Appendix 2 Stalybridge Network from ENW	39
Appendix 3 The Validation Results for the First Open-DSS Converted Network.....	40

1 Part A – Primary Substation Capabilities to Deliver Demand Response

1.1 Introduction

As part of the transition towards a low carbon economy, Electricity North West Limited (ENWL), the Distribution Network Operator of the North West of England, is involved in different projects funded by the Low Carbon Networks Fund. The University of Manchester is part of the Tier 2 project “Customer Load Active System Services (CLASS)”.

The aim of CLASS is to provide ENWL with greater understanding of the possible techniques to maximise the usefulness of their assets and potential provision of services to National Grid by actions undertaken exclusively at primary substation level. It addresses the following three distribution and transmission network issues:

1. Network congestion
2. Voltage rise issues in the HV distribution networks due to distributed generation
3. Need for more provision of fast and short-term reserves in the balancing market

The CLASS project will investigate and implement three solutions to tackle the above issues:

1. Peak reduction at primary substations: resulting from voltage changes obtained through on load tap changer (OLTC) actions
2. Reactive power absorption: resulting from tap staggering actions
3. Provision of fast reserves/frequency response: provided by the fast tripping of one parallel transformer and OLTC actions

A key aspect of the project is its ability to cope with different challenges only acting at primary substation level almost without any investment in new traditional assets. This novel approach has the potential to defer reinforcements and provide fast and short-term reserve services by DNOs to National Grid. This, in turn, could represent significant savings for end customers.

In particular this interim report focuses in the initial quantification on the benefits that can be unlocked in term of load reduction and its impact on customers' voltage. Firstly two different load modelling approaches are presented. An initial quantification of peak reduction considering these models is illustrated first on a single primary substation and then extended to all ENWL primary substations in an aggregated fashion. This will allow understanding the theoretical benefit of a peak reduction strategy.

However, to really quantify the benefits that this solution might deliver it is essential to properly assess the extent to which the voltage at the primary substation could be changed without negatively affecting the voltages of LV customers.

For the purpose the methodology to integrate LV network constraints in the assessment of the time-varying capabilities of primary substations in the context of demand reduction is discussed. First, an initial statistical quantification of LV network constraints due to changes in voltages is presented. Finally, an initial quantification of the allowable voltage reduction at primary substations is carried out adopting a time-series analysis and one real HV network.

1.1.1 Report structure

This document starts introducing definitions and then presents a literature review on load modelling both at aggregate level and per individual appliance in section 1. Section 1.2 deals with the “time-independent” load model whilst section 1.3 following the same structure describes the “time-varying” methodology. In section 1.4 the LV network constraints due to changes in voltages in the upstream network are evaluated. The corresponding methodology and initial results are presented. Thereafter section 0 assesses the time-varying voltage headroom for voltage reduction actions for a real HV

network modelled in OpenDSS. Finally, section 1.6 concludes this report summarising the main outcomes from the work carried out.

1.1.2 Steady-State Load Modelling: Definitions

Throughout this report terminology related to load modelling is used. Hence, it is important to highlight that all models discussed hereafter are for steady-state studies.

It is widely known and accepted that each electric load is characterised by its own voltage/power dependency. In particular, classification such as constant power, current and impedance have been widely used in the past. However, a recent growing interest in load modelling has highlighted the inaccuracies brought by load models based only on the previous approach [1]. A more sophisticated model called “exponential” is shown in the following equation.

$$P = P_0 \left(\frac{V}{V_0} \right)^{np} \quad \text{Eq. 1}$$

The key element in Eq. 1 is the np coefficient. It can adopt fractional values between 0 and 2 thus increasing the flexibility of the model – a feature not possible with the previous classification where np becomes 0, 1 or 2, respectively.

However, the accuracy of this model has been improved by the so-called polynomial (or ZIP) model (shown in Eq. 2) preferred model for in-depth analysis [2]-[3]

$$P = P_0 \left[Z_p \left(\frac{V}{V_0} \right)^2 + I_p \left(\frac{V}{V_0} \right) + P_p \right] \quad \text{Eq. 2}$$

$$Z_p + I_p + P_p = 1$$

All the above load models can be applied to a single electric “load”. This could be either a kettle (i.e., a single appliance) or the aggregated load at a primary substation (i.e., the aggregation of several thousands of smaller loads).

The non-exponential factors can be converted into exponential one through formulas without significant errors (when voltage variations are small, up to +/-5%). In addition, all the previous definitions could be extended to the reactive power.

1.1.3 Literature Review on Aggregated Loads (CVR)

Here the documents found in the literature are summarised in order to define in the most adequate manner the aggregated load model. This load model, typically the exponential one, is in most of the studies adopted in a way that the corresponding coefficients (i.e., np and nq) are fixed throughout the analysed period (e.g., day, season and year). Consequently, this particular use of fixed coefficients is called hereafter the time-independent load model.

From a detailed discussion in [4], the most suitable values to characterise the summer and winter loads using the time-independent model were found. Aspects such as year of study, country, customer composition, seasonality and voltage variation have been considered. The so obtained values are presented in Table 1

Table 1 Coefficients for the Load Model and Maximum Voltage Variation

	np	nq	ΔV_{\max}
Summer	0.8	4.0	$\pm 3\%$
Winter	1.1	3.5	$\pm 3\%$

Further investigation based on real monitoring data will be carried out in order to increase the confidence on the above coefficients particularly for the reactive power where less agreement seems to be reached.

1.2 Time-Independent Load Model

This chapter begins introducing a methodology to define the load profile at primary substation level. Thereafter, considering different combinations of load models and allowable voltage variations, the peak reduction capability is estimated. The calculations have been carried out for a single primary as well as for the whole ENWL area (349 primary substations).

1.2.1 Load profiling

In order to estimate the demand response at primary substation level a load profile under normal conditions must be defined. An initial estimation can be done by considering the available data listed below:

- Number of customer per ELEXON profile class (PC)
- ELEXON consumption pattern per customer class and per day 2012/2013
- Predicted yearly peak demand for 2012/2013 (by ENWL)
- Power factor (PF) at peak demand

Each profile class (PC) have an associated pattern defined by ELEXON [5] for each day of the year. Given that the number of customers per class and the associated daily profiles are known, a yearly profile at primary substation level can be obtained. With this yearly profile it is possible to identify the maximum peak that then should match the corresponding measured peak of the substation. If not, then the profile is scaled accordingly. The reactive power profile is obtained considering the PF at peak demand.

For illustration purposes, the load profiling methodology will be first applied to the primary substation called “Didsbury”, whose demand come mainly from residential customers. This primary experienced a peak of 16.18 MW with 0.97 PF the 2nd of February 2012. The resulting aggregated load profile is shown in Figure 1.

As shown in Figure 1, due to the predominance of the demand from PC1 and PC2 customers, this substation can be classified as “mainly domestic”.

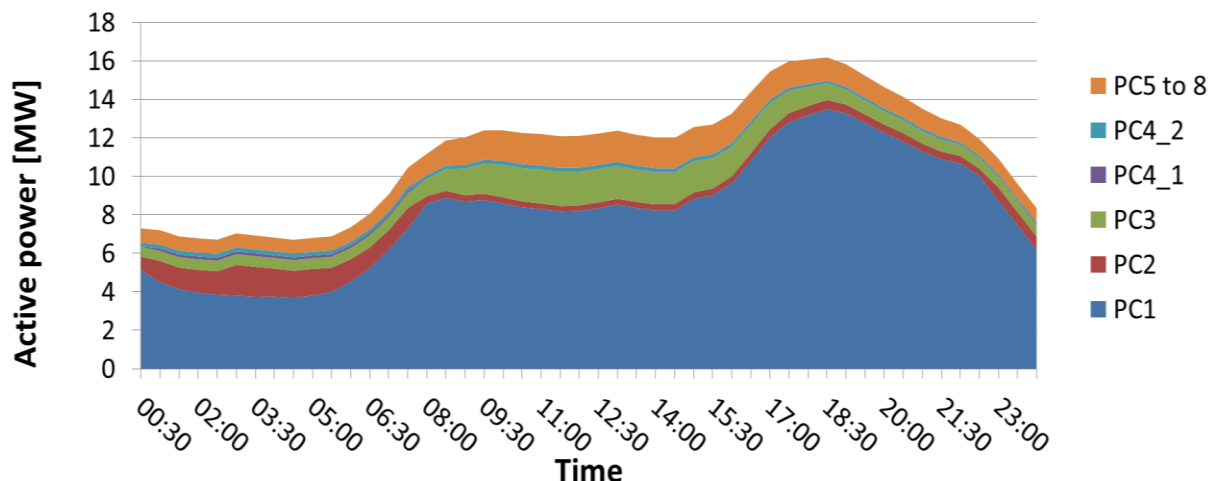

Figure 1 Estimated demand profile during the peak day, 13th December 2012

1.2.2 Peak demand reduction: Theoretical limit

Assuming several combinations of allowable voltage excursions, Δv , and $np-nq$ factors it is possible to determine the corresponding active/reactive power variations (using the formula for the exponential model as shown in Eq. 3).

P_0 is considered as the active power at rated voltage V_0 (i.e., 11 kV or 6.6 kV for a typical UK primary substation on its secondary side). Eq. 3 highlights how the relative power variation ($\Delta P_{p,u}$), consequence of a voltage change ($\Delta V_{p,u}$), is constant throughout the day (i.e., peak and not peak period) as the only variable (once $\Delta V_{p,u}$ has been fixed) is np which is assumed constant in this time-independent load model.

$$P = P_0 \left(\frac{V}{V_0} \right)^{np} \Rightarrow P_{p,u} = \left(\frac{V_0 - \Delta v}{V_0} \right)^{np} = (1 - \Delta v_{p,u})^{np} \Rightarrow \Delta P_{p,u} = 1 - P_{p,u} = 1 - (1 - \Delta v_{p,u})^{np} \Rightarrow \Delta P_{\%} = 100 \cdot \Delta P_{p,u} \quad \text{Eq. 3}$$

Applying the aforementioned equation to the estimated load profile for Didsbury the achievable active and reactive power reductions (in absolute) at peak time (18:30) are shown in Table II.

Table II Absolute active power reduction ΔP in MW at peak demand (18:00-18:30, 16.18 MW) for different $np-\Delta v$ combinations for Didsbury primary substation

		ΔV		
		6%	3%	1.5%
np	2	1.88	0.96	0.48
	1.4	1.34	0.68	0.34
	1.1	1.06	0.53	0.27
	0.8	0.78	0.39	0.19

In the above table, the maximum achievable power variation at peak demand was explored using as limit values $np=2$ and $\Delta v=6\%$. Such an np implies 100% resistive load and change in voltage of 6% is likely to lead to violations of the statutory limits [6]. Hence, this np and ΔV values adopted in Table II represents an extreme and the theoretical scenario, unlikely to be reached in reality.

For this particular substation, the theoretical np and ΔV values would result in a peak reduction of 1.88 MW out of 16 MW (i.e., 11.6%). Nevertheless, although this is not achievable in reality, it provides a valuable insight in terms of the benefits of such an approach. It is important to highlight that the above quantification is for illustration purposes and does not necessarily consider feasible combinations of np and ΔV (or nq and ΔV).

1.2.3 Peak demand reduction: Capability assessment

Based on the literature, a set of realistic $np-nq$ values with allowable voltage variations (ΔV_{\max}) have been defined (see Table 1). This, however, is limited to aggregated residential demands. Industrial and commercial customers have not been considered in this report.

The quantification of peak demand reduction carried out in the previous section can now be adapted to consider these more realistic values from Table 1 (winter). Hence, adopting Eq. 3, Table 3 and Table 4 present the peak demand reduction for Didsbury, in absolute and percentage values, respectively.

Applying the values from Table 4 the potential seasonal demand response for Didsbury is shown in Figure 2. The estimated yearly demand based on ELEXON profiles (see paragraph 1.2.1) has been adopted for this purpose. The absolute low demand response for summer period is justified by the combination of low np (0.8) and absolute low demand in such period.

It is important to remark that the estimated active and reactive power changes in Table 4 are valid for all domestic primary substations. Indeed $\Delta P\%$ in Eq. 3 is not correlated to the specific substation but only to the assumed np (that comes from studies on residential demand response). This is due to the fact that, up to now, we are adopting a simplified technique to model residential demand.

Table 3 Estimated peak reduction for Didsbury ($np=1.1$, $nq=3.5$ & $\Delta V=3\%$)

ΔP [MW]	ΔQ [Mvar]
0.533	0.410

Table 4 Estimated seasonal active/reactive power variation (in %) at Didsbury

	Summer/Spring			Winter/Autumn		
	$np=0.8$	$nq=4.0$	$\Delta v=3\%$	$np=1.1$	$nq=3.5$	$\Delta v=3\%$
Active power variation $\Delta P\%$	2.4%			3.3%		
Reactive power variation $\Delta Q\%$	11.5%			10.1%		

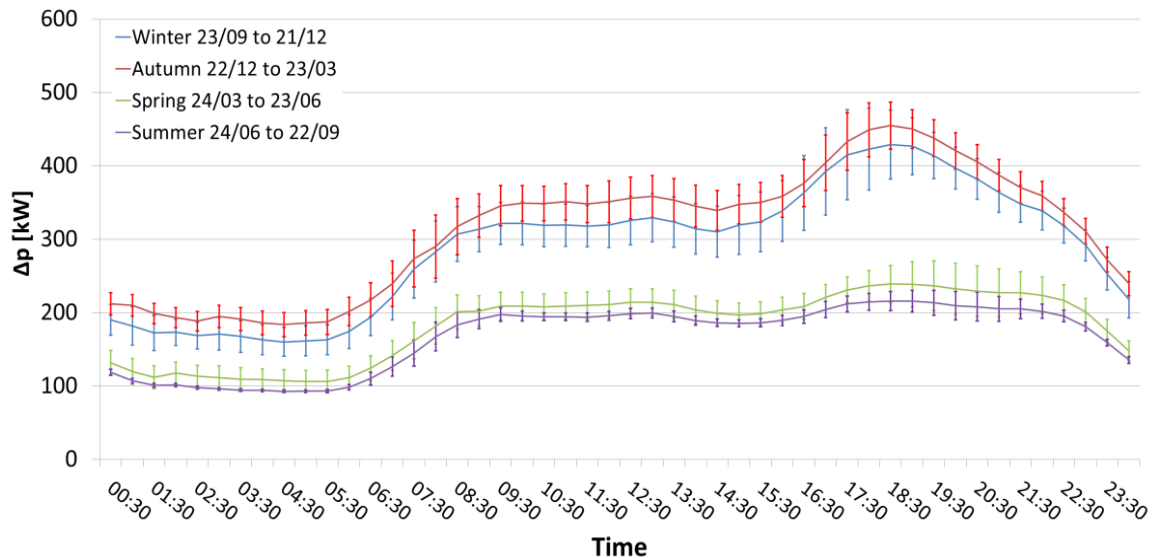

Figure 2 Seasonal average and standard deviation active power variation achievable in Didsbury primary substation

Therefore, by applying the relative changes from Table 4 to all primary substations owned and operated by ENWL, it is possible further analyse the corresponding contributions to peak reduction.

Figure 3 presents the distribution of absolute peak reduction among all 349 primary substations. About 37% of primaries could achieve a peak reduction between 0.35 and 0.5 MW. Although this is a significant proportion of primaries, it is important to highlight that for this quantification all peak loads have been considered to be entirely domestic.

In aggregate a total of 143.74 MW of peak reduction in ENWL area is obtained considering all substations peaking at the same time. Although in reality not all substations have their peaks coinciding in time and day, this value could be considered as an upper limit. In addition, it is interesting to remark that when adopting the np and Δv assumed by ENWL's CLASS proposal (submitted to Ofgem) by the proposed methodology, a good agreement in the aggregated peak reduction is achieved (11.76 MW against 11.25 MW).

1.2.4 Limitations of the approach

The main objective of this chapter has been the estimation of active/reactive power peak reduction. Based on the literature review related to conservation voltage reduction (CVR), a realistic set of values for np , nq and Δv has been identified and used for both a single substation (Didsbury) and the ENWL area. Nonetheless, a number of caveats need to be noted:

1. np/nq constant throughout the day: In reality the power response to a voltage variation will change due to the changing load composition throughout the day.
2. The adopted np/nq were based on the literature review (mainly from USA). No measurement-based studies were found for the UK.
3. Only residential demand has been considered.
4. No network studies have been carried out to estimate the effects on end customers.

Consequently, although caution should be taken when reading the above results, the findings represent an ideal starting point to assess the potential peak reduction capabilities of CLASS.

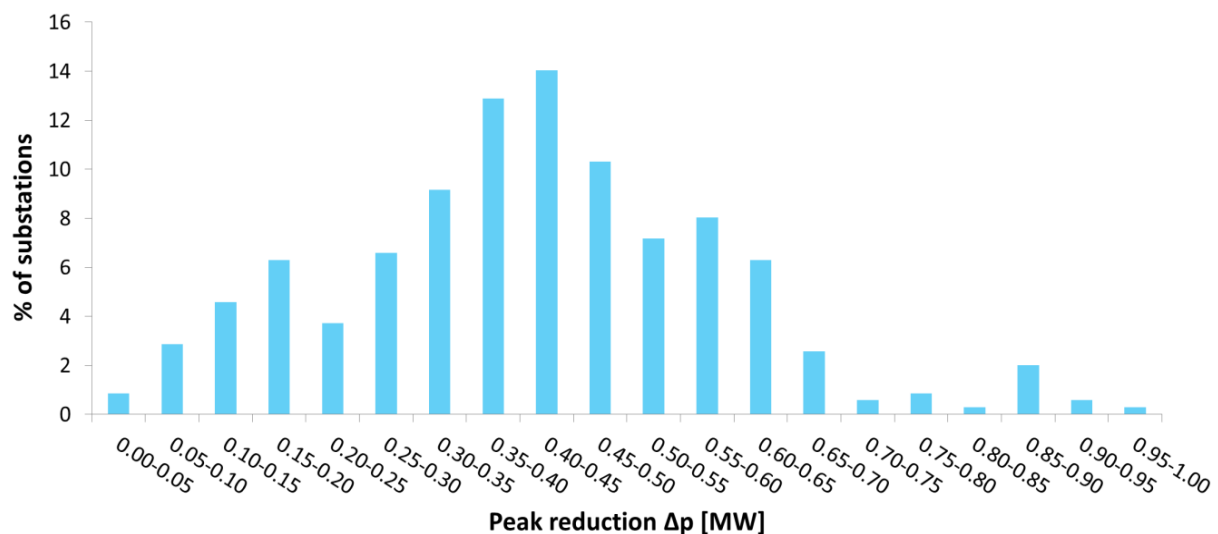

Figure 3 Peak reduction with $np=1.1$ and $\Delta V=3\%$ for all primary substation in ENWL area

1.3 Time-Varying Load Model

This chapter investigates a more sophisticated technique to model residential demand. In particular, a bottom-up approach will be developed in order to introduce a “time-varying” domestic load model with one minute resolution.

The adopted technique, detailed in [4], is summarised in Figure 4.

First a literature review has been carried out in order to define a ZIP model for each single appliance that could be found in a common UK dwelling. Thereafter, by adopting an improved version of the freely available CREST tool [7], the load profile for each dwelling has been stochastically generated. Then, the daily ZIP model for each dwelling is calculated by aggregating each single appliance model (i.e., “Aggregation 1” in Figure 4). Finally, considering the number of PC1 and PC2 customers in a given primary substation, the “Substation demand load model” for the residential demand can be produced by a further aggregation process (i.e., “Aggregation 2” in Figure 4).

1.3.1 Load profiling

This first section describes the adopted methodology to stochastically generate dwelling load profiles. The peak demand reduction is estimated in the subsequent section.

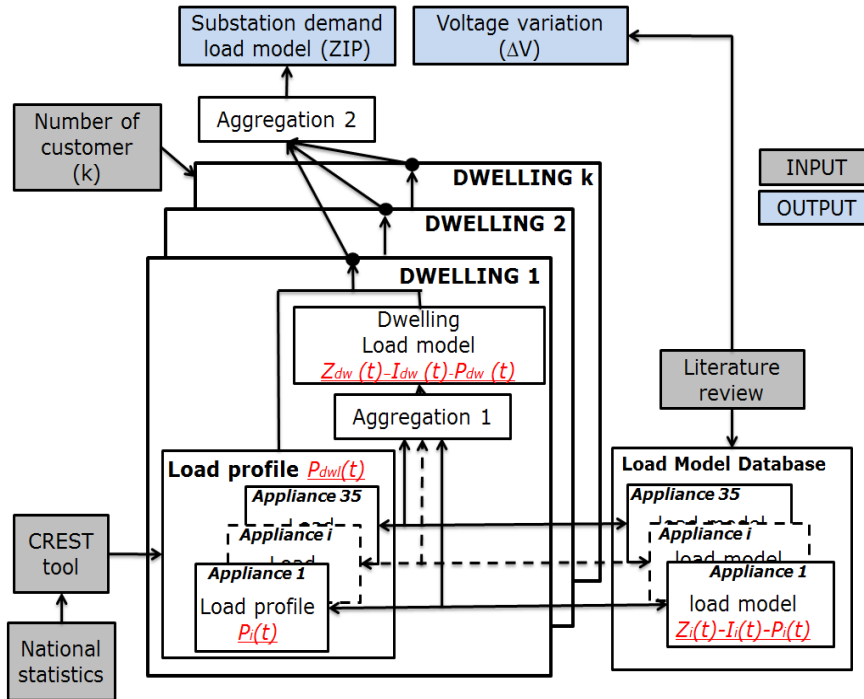

Figure 4 Adopted time-varying approach to model the residential demand, [4]

1.3.1.1 CREST tool [7], [8]

For the specific UK residential sector, Loughborough University carried out a study in 2010 [17] based on a national time of use survey. The main outcome of this study was a freely available Excel VBA tool [30]. This tool is called hereafter the “CREST tool”. The tool simulates how people in a dwelling are interacting with electrical appliances (e.g., watching TV, cooking, ironing etc.) and based on statistical data the electric consumption per single appliance and finally the demand profile per dwelling. Repeating the process for every customer it is possible to obtain the aggregate power during peak demand (January, weekday) for Didsbury as shown in Figure 5.

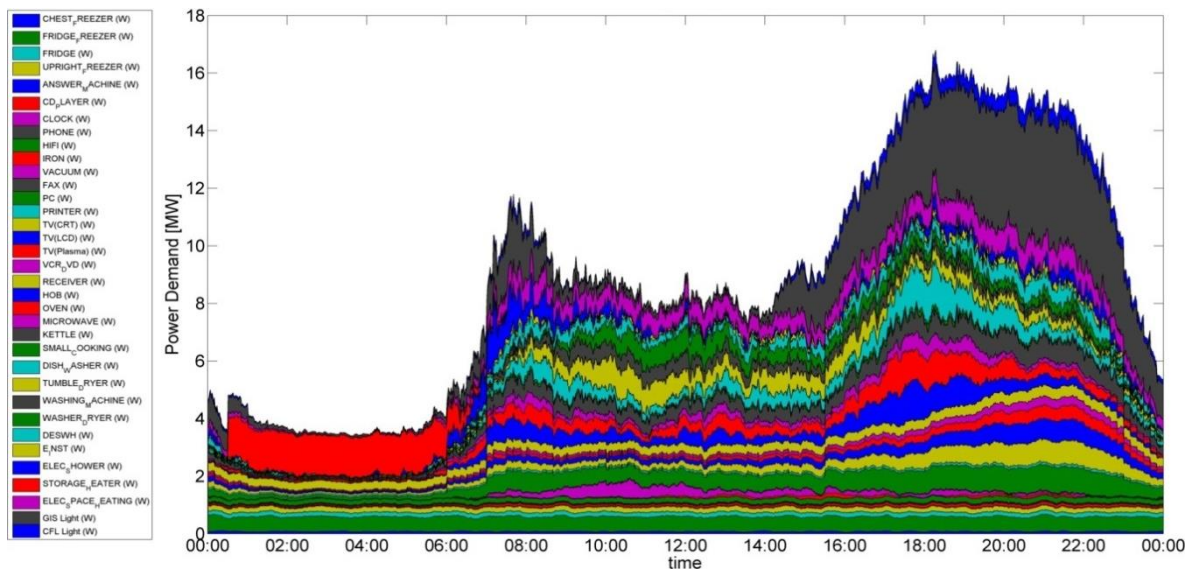

Figure 5 Aggregated active power and breakdown per appliance during peak demand for Didsbury primary substation

1.3.2 Peak demand reduction: Capability assessment

This section estimates the peak reduction capability for the substation under study by developing a time-varying load model.

Following the process summarised in Figure 4 and detailed in [4], the aggregate load model for Didsbury primary substation for the considered peak day (02/12/2012) is illustrated in Figure 6. For simplicity, the equivalent np and nq values are used instead of the ZIP parameters.

For the np factor a steady behaviour during night hours (i.e., a consequence of the constant load composition) is followed by a steep rise in the early morning peaking to 1.3 at 8:00 a.m. This is a consequence of the morning activities (such as taking a shower) carried out by most people in these hours. A slight decline down to 1.15 followed by an almost steady trend characterises the remaining hours.

The nq factor, likewise, shows an almost constant value during night hours. A strong drop at 8 a.m occurs because of the high proportion of resistive loads (electric shower). This is followed by an oscillating behaviour during the rest of the day

The main advantage of the time-varying methodology is that allows a more accurate estimation of the aggregated load model based on the likely composition of appliances used throughout the day. For instance the value of 1.1 for np factors, typically found in the literature (see Table 1), can be considered an overestimation during night hours but also an underestimation during the rest of the day (as shown in Figure 6). As for the nq factor, the time-independent value of 3.4 can be considered an overestimation at all times.

Figure 7, based on the load model shown in Figure 6 and aggregate demand in Figure 5, shows the absolute potential power variation throughout the peak day considering a voltage change of 3% for Didsbury primary substation. Note that this variation is up or down depending on whether a voltage rise or drop is applied, respectively.

To have an idea of the extent to which all the primary substations in the ENWL area could respond to voltage changes, the np factor found above during peak demand ($np=1.27$, 18:00) is used.

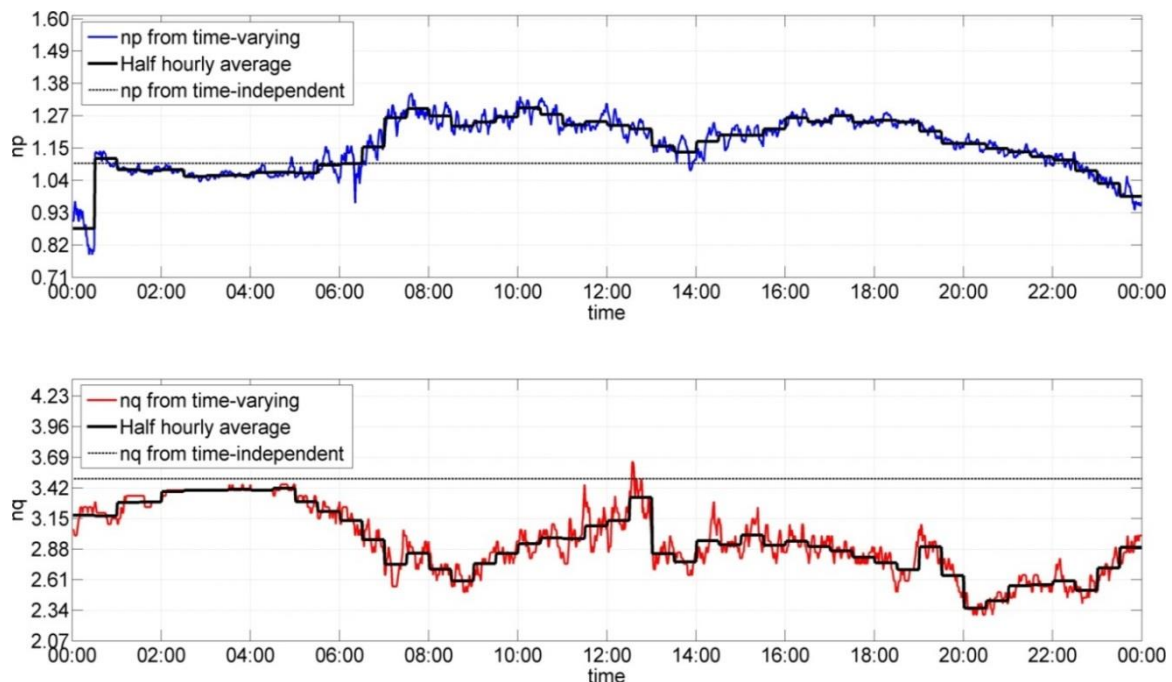

Figure 6 np and nq factor for the peak day for Didsbury primary substation

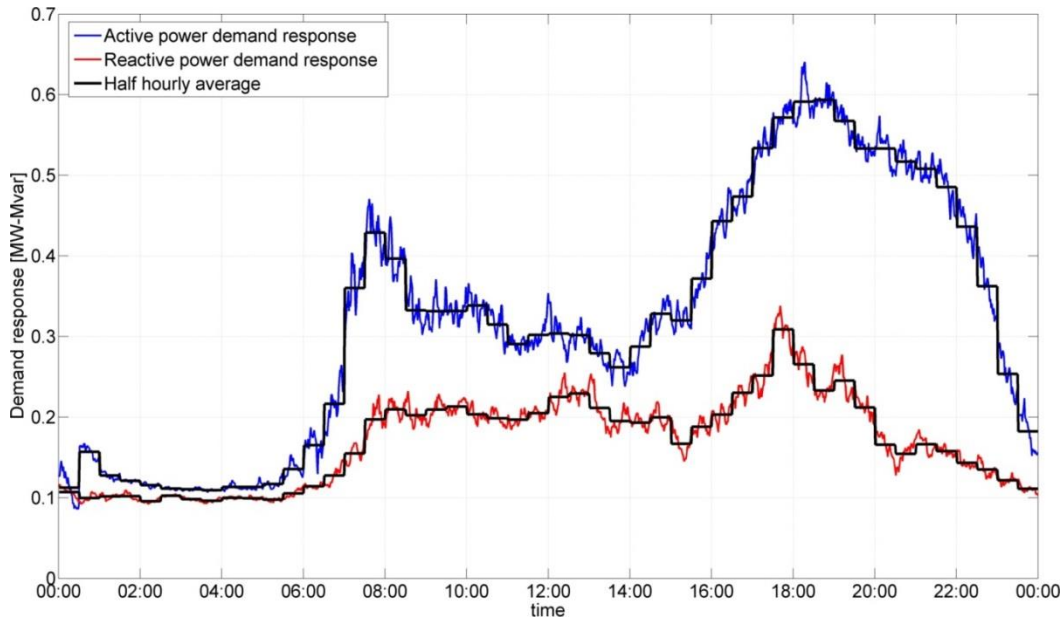

Figure 7 Potential active and reactive power variation at peak demand day for Didsbury primary with half hourly average ($\Delta V=3\%$)

Assuming that the demand is purely domestic and the occurrence of a simultaneous peak, the ENWL area could potentially reduce 165.53 MW. However, it is very likely, as shown and discussed previously, that outside peak hours, any estimation of demand response will significantly differ between the time-varying and time-independent models.

1.4 LV Network Constraints: Initial Assessment

The benefits that the voltage-led demand response scheme proposed in CLASS might deliver are limited to the extent to which the voltage at the primary substation could be changed without negatively affecting the voltages of LV customers. Consequently, the analysis of the involved HV network and associated LV feeders should be addressed simultaneously in order to evaluate the limit of any voltage-led demand response scheme. However, it is not practical to analyse every single LV feeder. For instance, the 60 HV networks used in the CLASS project feed around 350,000 customers. This equates to about 7,000 LV feeders (assuming 50 customers per feeder).

In this Section the problem is addressed by analysing a set of 57 LV residential feeders from the Low Carbon Networks Fund (LCNF) project “LV Networks Solutions” [9]. In particular, the voltage on the primary side of LV transformers is statistically assessed to quantify the percentage of BS EN 50160 non-compliant customers. This allows defining the range of voltages that lead to an acceptable risk of having a certain number of non-compliant customers. A Monte-Carlo approach has been adopted for this purpose. The results will then be generalised and applied to LV transformers in the studied HV networks.

1.4.1 Methodology

A Monte Carlo approach has been applied to the selected 57 LV feeders from the project “LV network Solution” [10] feeders. A Monte Carlo procedure [11], is below summarised for one feeder:

- **Step 1.** A feeder is selected from the 57 available
- **Step 2.** Its primary side voltage is considered constant for the whole day. Then, for a given simulation, random load profiles [7] are allocated to the customers in the analysed feeder
- **Step 3.** A load flow is run in OpenDSS and the number of non-compliant customers with BS EN 50160 is obtained. This procedure (for the same feeder and primary side voltage) is repeated for 200 winter days (called a simulation).

- **Step 4.** Once this process is finished, the primary side voltage of the LV transformer is increased by 1.5% (in agreement with the typical step size of the OLTC). The Monte Carlo procedure is run again for another 200 simulations.

At the end of analysing each different primary side voltage (step 4), the percentage of non-compliant customers is obtained for every simulation (200). The final value for a given primary side voltage and feeder is calculated as the average of those (200) simulations corresponding to the 95th percentile (to exclude outlier simulations). Repeating the previous process for all the 57 feeders a total of 855 values are obtained.

These values, presented in Figure 8, represent the average percentage of non-compliant customer per feeder (horizontal axis) for the simulated primary side voltages (vertical axis). It can be seen that a range between 0.94 and 1 pu leads mostly to 0% of customers with voltage issues. On the other hand, values below 0.88 pu and above 1 pu result in almost 100% of customers non-compliant with BS EN50160. For more detail referer to [11]. It is worth noticing that the following assumptions have been adopted in the analysis:

1. A natural transformer boost of approximately 8% [12].
2. A nominal tap position (i.e., tap position 3) for the off-load tap changer.
3. Every feeder has been considered individually.
4. Only winter load profiles are considered in this initial assessment.
5. The BS EN 50160 was used considering daily simulations.
6. The voltages at the primary side of the LV transformers have been assumed constant throughout the day.

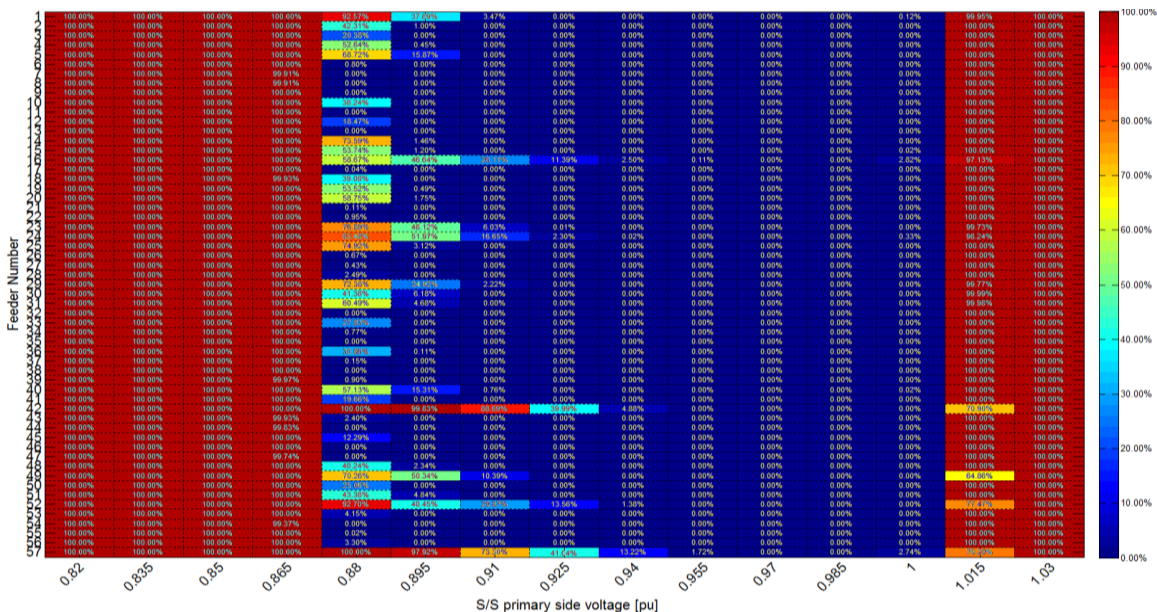

Figure 8 Average percentage of non-compliant customer per feeder and LV transformer primary side voltage

1.4.2 Initial Results

The Monte Carlo approach has generated 855 values as shown in Figure 8. Each corresponds to the average percentage of non-compliant customers¹ per feeder and investigated primary side voltage. For instance, for feeder 1 (1st row from the top in Figure 8) and primary side voltage of 0.895 pu (6th column from the right in Figure 8) the average percentage of customers with problem is 37.69%.

The results in Figure 8 are further summarised in Table V. This is done by averaging, for the same primary side voltage, the percentage of non-compliant customers for all the feeders. Table V suggests

¹ 855 = 57 (feeders)*15 (primary side voltage values)

that for a given primary side voltage between 0.94 pu and 1 pu the average percentage of customers with problem is below 1%. However, if a less conservative figure of 5% of non-compliant customers is adopted, a wider voltage range from 0.91 pu to 1 pu could be considered.

Table V Average % of customer with problems per primary side voltage range

Primary side voltage of LV transformer [pu]	0.82-0.88	0.895	0.91-0.925	0.94-1.00	1.015-1.03
Average % of customers non-compliant	>10%	5-10%	1-5%	<1%	>10%

Table V represents valuable information in deciding the extent to which a voltage variation can be implemented at primary substations. Indeed, once the corresponding HV network has been analysed, it is possible to verify whether or not the voltages at the primary side of the LV transformers lay within the acceptable range presented in Table V. If so the analysed voltage configuration (voltage target at the primary substation) might be considered as “low-risk” for the downstream connected LV customers.

1.4.3 Limitations of the approach

The 57 LV network models adopted in this report have been produced by the “Low Carbon Network Solutions” project run by ENWL [10]. Despite the realistic nature of these models, some limitations exist and therefore assumptions had to be made. This is detailed below.

- The customer phase connection is not always available. In these cases the customers have been equally spread among the phases.
- Some cables do not present any information about their type (e.g., section, insulation, etc.). Thus, the most common cable impedances for similar sizes were used.
- UK LV networks mainly adopt a protective multiple earth (PME) system in which the neutral conductor is grounded at several points. However, the data associated with the extent and location of these connections were not available and therefore not included in the models.

In addition, it is important to highlight that the voltage range previously defined (i.e., 0.94 to 1 pu with 1% of non-compliant customers) is obtained after two “averaging” processes. Consequently, every percentage of non-compliant customers associated with a specific primary side voltage at LV transformers is the summary of 11,400 simulations² [11]. Indeed most of the feeders, Figure 8, do not present any voltage problem (i.e., 0% of non-compliant customers) within the defined “low risk” range of 0.94 to 1 pu.

Finally, feeders with a small percentage of customers flagged as with voltage issues are likely to, in practice, not experience any negative effects. This is because the analysis flags a customer as non-compliant whenever its supply voltage violates the statutory limits (even for a fraction of Volts and/or for only one instant in the whole day).

Based on the above, the voltage range defined in Table V as “low risk” (0.94 to 1.0 pu) can in practice be considered as “no risk” as the tiny, sporadic voltage excursions, quantified by the computer-based simulation, in reality will pass unnoticed by customers and its appliances.

1.5 HV Network Time-Series Analysis

The objective of this section is to provide an illustrative example on how the LV customer constraints (quantified in section 1.4) will be integrated in HV network studies for time-series analyses considering an arbitrary day. A real HV network (Romiley) is adopted for the purpose.

² 11,400 = 200 scenarios per LV feeder * 57 LV feeders

1.5.1 Daily Power Flow Analysis

From the knowledge on the number of customers per Profile Class (PC)³ that every LV transformer feed in Romiley HV network, it is possible to generate an aggregate demand profile for each of them. The day chosen for the analysis is 3rd September⁴ (weekday).

With the network topology and the demand profile for every LV transformer a first power flow study is carried out (in this case, using OpenDSS [13]) with the aim to quantify the voltage profile along the HV network. For simplicity, the voltage on the primary side of the primary substation has been assumed constant at 1 pu. Figure 9 illustrates the voltage heat map of the HV network during peak demand (at 18:30).

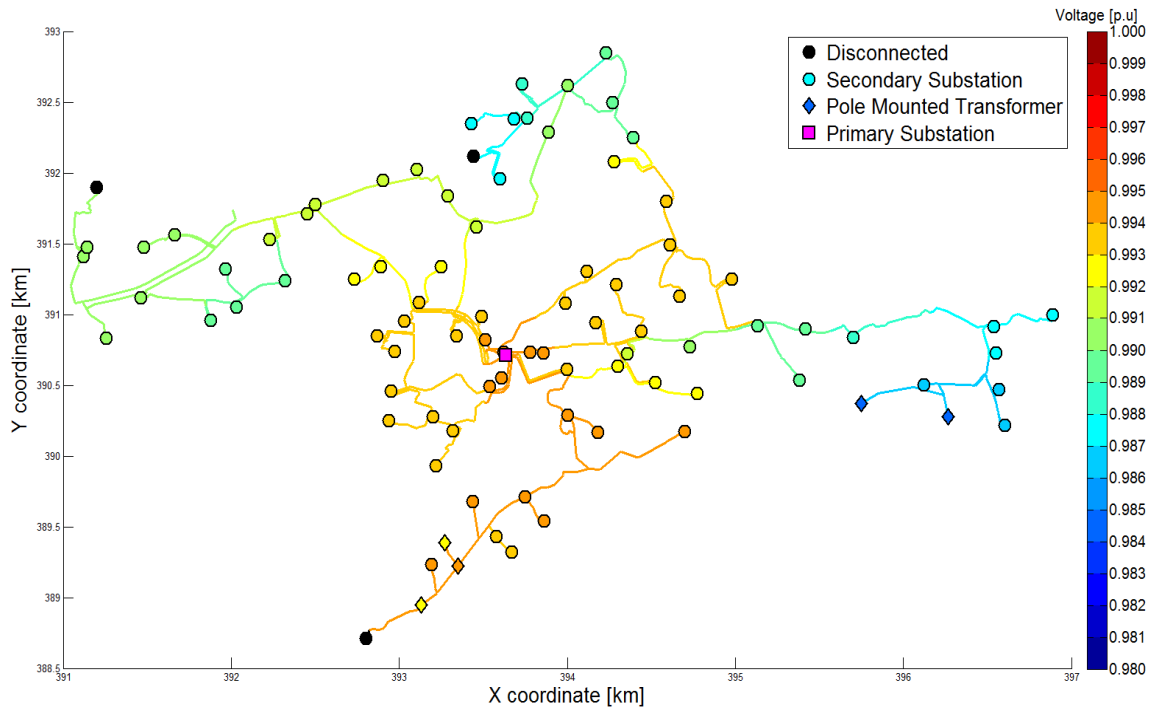

Figure 9 Romiley HV network voltage heat map at 18:30 (3rd September)

As expected the secondary substations closer to the primary present higher primary side voltages (around 0.996 pu, orange in Figure 9) whilst the farthest ones show the lowest voltage values (around 0.981 pu, blue in Figure 9). These substations might represent the bottleneck for a voltage reduction action as their LV customers might experience, earlier than others, unacceptable voltage levels.

1.5.2 Voltage Headroom Assessment

Figure 10 shows the voltage profiles (obtained from power flow simulations) on the primary side of every LV transformer for the analysed day. These results in conjunction with the LV customer constraints from section 1.4.2 allow determining when and to what extent a voltage-led demand response can be introduced for the analysed day (at half hour resolution in this example).

Assuming that the average percentage of customers with problems should be maintained below 1%, the voltage on the primary side of every LV transformer should be kept within 0.94 and 1 pu (as detailed in Figure 8 and Table V).

³ A profile class represents the daily half hour average pattern of electricity demand of a segment of supply market customers generated by ELEXON

⁴ The adopted ELEXON profiles are those of the calendar year 2012. The 3rd September 2012 was Monday

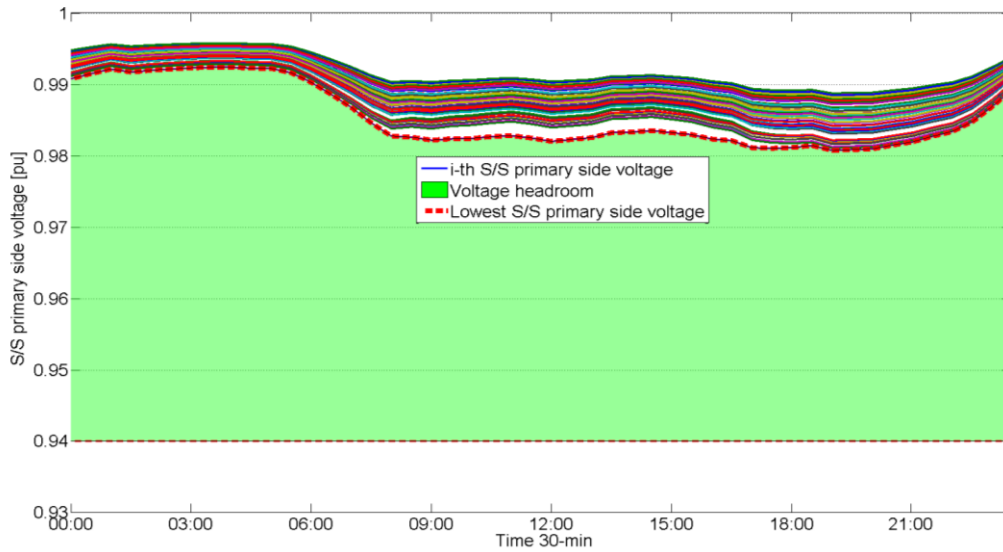

Figure 10 Estimated voltage headroom (green area) for voltage reduction for Romiley primary substation (3rd September)

For simplicity, a linear relationship between voltage at the primary substation and voltage along the HV network can be assumed (i.e., 1% voltage reduction at primary substation causes 1% voltage reduction in every point of the downstream HV network).

Consequently, the voltage headroom for Romiley is given by the widest voltage reduction that does not bring the primary side of any LV transformer below 0.94 pu. This voltage headroom for the 3rd of September is illustrated in Figure 10 by the green area. The allowable voltage range is limited by the LV transformer with the lowest primary side voltage (lowest dashed line in Figure 10, located on the right hand side in Figure 9).

Finally, dividing the voltage headroom by the voltage amplitude of one tap step at the primary substation (i.e., 1.46% from [14]) the allowable number of tap changes (for voltage reduction purposes) is illustrated in Figure 11.

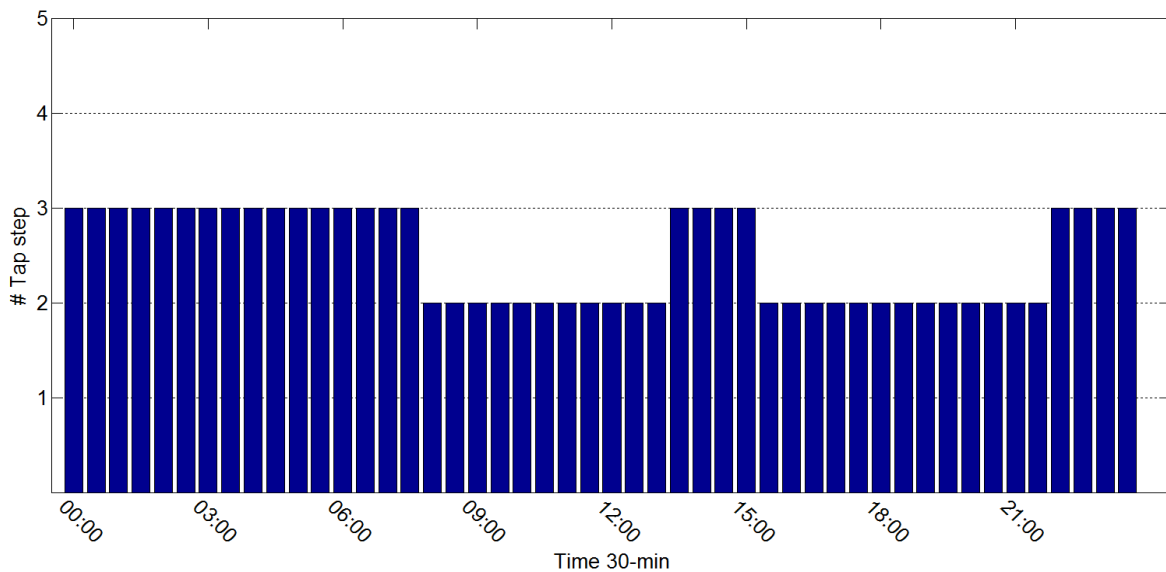

Figure 11 Potential number of tap changes for voltage reduction purposes in Romiley primary (3rd September)

For this case of study it is possible to change up to 3 taps⁵ without exceeding 1% of BS EN 50160 non-compliant customers. However, during peak demand (around 12:00 for mainly commercial secondary substations and around 18:30 for mainly residential ones), due to the higher voltage drop along the HV network, only 2 taps are allowed.

1.5.3 Limitations of the Approach

Although the example illustrated in this section shows how HV and LV network studies might be adopted to assess the capability of a primary substation in terms of voltage reduction, a number of caveats should be noted.

The adopted ELEXON profiles are averages based on a high number of customers. Consequently, while they might be reliable to represent the aggregated demand of high number of small customers (such as the hundreds of PC1 users fed by a secondary substation) the same cannot be claimed for a single big consumer (PC6-PC8).

In addition, a category of customers called PC0 (both HV and LV) have been neglected as no information (apart from their name) is available at the time of writing.

Moreover, the voltage on the 33kV side of the primary substation has been assumed constant (1 pu). Therefore, the voltage at the 11kV busbar will be affected only by the voltage drop inside the primary transformer. The effects due to the actual tap setting (that might be different from nominal position) and/or voltage fluctuations in the upstream network are neglected.

In addition care should be taken when reading these last results as only one example of a specific HV network during one day only has been considered. Other HV networks in different period of the year might provide different outcomes.

In future study those issues, in the limit of the available data, will be addressed.

1.6 Conclusions – Part A

This document presents the progress of the Low Carbon Networks Fund Tier 2 project “Customer Load Active System Services (CLASS)” run by Electricity North West Limited (ENWL).

This report has firstly presented and discussed the modelling aspects and initial findings of the demand response (aggregated at primary substation) to changes in voltages. In particular two different load modelling approaches were introduced: a “time-independent” model and a “time-varying” model. The former applies fixed load parameters throughout the day, whereas the latter undertakes a bottom up approach in which each single domestic appliance load model is aggregated (at the primary substation). In both cases, only residential demand was considered.

The proposed time-varying model demonstrated that due to changes in residential load composition throughout the day, the potential demand response also varies (not captured by the time-independent model). Consequently, it is crucial that any future analysis considers this more advanced modelling.

To illustrate the above approaches, a winter day of the primary substation Didsbury was analysed with both methodologies. Although the results were different throughout the day, they were consistent at peak time. Considering a 3% voltage reduction the main results from the “time-varying” load model are summarised below:

- Active power reduction of 3.7%, (i.e., 0.6 MW out of 16.18 MW) at peak
- Reactive power reduction of 7.6% (i.e., 0.31 Mvar out of 4.06 Mvar,) at peak
- Varying load model parameters throughout the day

The above methodology to assess the potential peak reduction was also applied to 349 primary substations (most of the ENWL license area) assuming a residential behaviour of demand (which is a

⁵ It means from tap position 0 (no boost/no reduction) to tap position +3 (reduction of $1.46 \times 3 = 4.38\%$)

very optimistic assumption) and coincident peaks. The results listed below correspond to the time-independent model:

- The aggregated peak reduction is estimated to be 143.74 MW (out of 4362 MW, 3.3 %).
- About 37% of the primary substations (130) could achieve a peak reduction between 0.35 and 0.50 MW, i.e., an aggregated peak reduction of 54.8 MW (1.25% of total peak).
- In general, an almost linear relationship of 1:1.2-1.3 was found between voltage changes and demand reduction/increase. This was in agreement with most literature found to date.

In this analysis the impact of OLTC actions on customers voltage has not been addressed. For this purpose, the methodology to integrate LV network aspects in the assessment of the time-varying capabilities of primary substations in the context of demand reduction is introduced. In particular a Monte Carlo approach has been applied to 57 LV feeders considering 200 simulations, each of them representing a winter day. To study the effects of voltage changes in the HV network different voltage values at the primary sides of the LV transformers (assumed at tap position 3) were investigated (kept constant throughout the day for simplicity). The outcomes highlighted that to maintain the average percentage of BS EN 50160 non-compliant customer below 1% (called a “low risk scenario”) the voltage on the HV side of every LV transformer should be maintained between 0.94 and 1 pu. However, if a less conservative figure of 5% of non-compliant customers is adopted, a wider voltage range from 0.91 to 1 pu could be considered.

Finally, for one real HV network (Romiley) an initial time-series analysis has been carried out. This analysis has illustrated how the voltages at the primary side of LV transformers and its relationship with BS EN 50160 non-complaint customers can be integrated in future HV network studies. It was found that the achievable voltage reduction that can be introduced assuming a “low risk scenario” in terms of non-compliant customers (i.e., less than 1%) corresponds to up to 3 tap positions at the primary substation for this specific case of study. It was also shown, as expected, that this value varies during the day.

2 Part B – Primary Substation Capabilities to Deliver Reactive Power Absorption

2.1 Introduction

The power sector decarbonization is expected to result in more distributed generation (DG) with renewable resources to be connected into distribution networks. However, during periods of low demand, the network voltages may exceed the acceptable limits due to the growing DGs. The overvoltage problems also occur in the transmission systems. The main reasons include the development of underground cables in distribution and transmission networks, the decommissioning of coal generators in specific areas and reduction in reactive demand. Distribution network operators can provide reactive power support as an auxiliary service to help National Grid manage reactive power balance in transmission networks.

As a part of ENWL CLASS project, this report part B presents a reactive power absorption control method, which carry out a staggered tap operation on the existing parallel transformers in distribution networks, to provide reactive power absorption to support the transmission systems during periods of low demand. The staggered tap operation of parallel transformers will introduce a circulating current around the pair of the parallel transformers. Due to the inductance of the parallel transformers, the circulating current will draw more reactive power from the upstream network. Considering the losses and overloading of the parallel transformers, a constraint of the limited number of stagger taps (suggestion up to 4 stagger tap numbers) should be considered. This will limit the reactive power absorption capability from each pair of parallel transformer. However if considering a large number of pair of parallel transformers in the distribution network, the resulting aggregated VAr absorption within the overall distribution networks could be sufficient high to support the transmission systems

This report of Part B, firstly, presents the methodology to study the whole ENWL EHV distribution network reactive power absorption capability during the consideration of stagger tap operation. According to the number of Grid Supply Point (GSP) from NG to ENWL networks, they can be divided as 18 sub-networks. Two representative sub-networks are selected as the initial studies. One is the South Manchester network which is the medium size sub-network with typical domestic loads and a number of distributed generators. The other is Stalybridge which has the mostly loaded network without distributed generators.

Although the whole ENWL EHV network in IPSA (Interactive Power System Analysis) model [17] was given, it has been limited to the network power flow design and planning studies. In order to be able to incorporate the network simulation tool with the proposed stagger tap operation method, the ENWL EHV network has been converted to OpenDSS [18] for the studies. The converted OpenDSS models are validated through comparing the voltages and power flows between IPSA and OpenDSS models under different network operating conditions.

To exam the correctness of the stagger tap operation, a matrix database search method was designed and implemented. The method was applied to the converted South Manchester network Open DSS model. The results were examined and analysed.

Finally, the Q absorption capability of both South Manchester and Stalybridge networks under 4 stagger tap operation constraints were simulated and analyzed. By applying data averaging method, the overall capability across the whole EWNL EHV distribution network has been estimated. Although even considering the maximum 4 stagger tap operation constraint to the CLASS project, some parallel transformers may be limited to 3, 2 or 1 or even 0 stagger tap operation due to their tap reference position at highest or lowest load flow conditions, respectively, the overall capability across the whole EWNL EHV distribution network should be smaller than the estimated. Conclusion is drawn to confirm the EHV network reactive power absorption capability across ENWL's network.

2.2 Methodology

The methodology flow chart for WP2 – network reactive power absorbability studies is shown in Figure 12. It consists of three parts: (i) ENWL network modelling tool selection, (ii) state estimation for the network observability, and (iii) parallel transformer tap stagger control method.

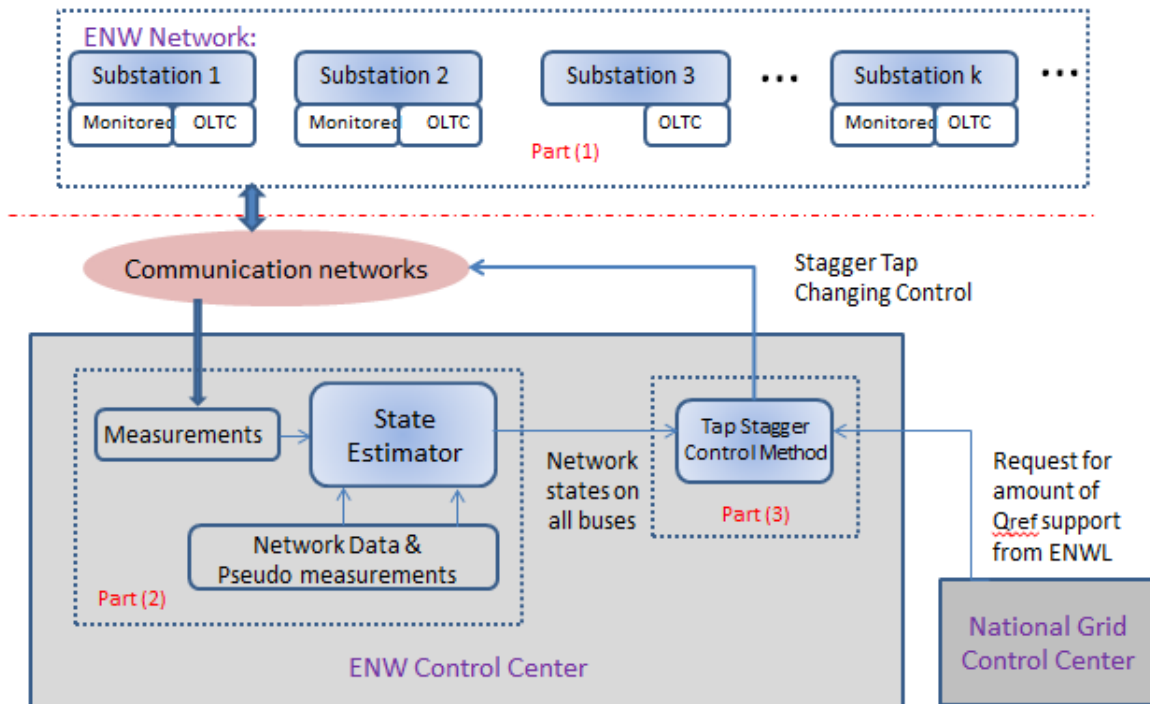

Figure 12: Methodology flow chart of WP2 – network additional Q absorbability study

Part 1 at the top of figure 12 presents ENWL network. Some of the substations are monitored which have communication channels to the control centre. However, most of substations are not monitored, therefore the substation operational conditions, such as voltage and power flow, are not known. To achieve the observability for these unmonitored substations, the state estimator as part 2 shown in figure 12 is used to provide the observable whole network operational conditions.

The state estimation considers both real time measurements and pseudo measurements to provide the whole network observability, such as voltage magnitude and angle, real and reactive power. The real-time measurements are obtained from the monitored substations and the pseudo measurements are obtained from load estimation (mainly from historical load database) for those unmonitored substations.

Part 3 in figure 12 is the tap stagger control method. The tap stagger control method can vary from a simple method, such as a sequential pair of parallel transformer selection method, to a complex one, such as different optimisation method. In this study, a matrix/database method has been selected. The method pre-calculated the relationship between the available reactive power in each parallel transformers and the number of the tap stagers at various load conditions to form a matrix database.

The method will use the state estimation data, including all substation voltage and power flow states as well as transformer tap positions, and the request amount of Q absorption from National Grid to carry out the search the matrix database to determine which pairs of parallel transformers in the network and how many tap stagers will be used to provide the required Q support from National Grid to the transmission networks.

Since the whole ENWL network consists of 18 GSPs, the network has been divided into 18 subnetworks. Initially two subnetworks (South Manchester and Stalybirdge) are selected and converted from IPSA model into OpenDSS model, therefore these network power flows in cooperate with the tap stagger control method can be simulated and studied in a time series according to the daily and yearly load conditions. Based on the simulated Q absorption capability studies and the number of pair of parallel transformers in the selected two sub-networks, and by considering the data averaging method, the whole ENWL network Q absorption capability to support National Grid transmission network can be estimated. Details of the work are described in the following sections.

2.3 Network Modelling Tool Selection

2.3.1 Sub-network selection

The whole ENWL distribution network as shown in figure 13 consists of 18 GSP with many hundreds of substations mainly at 33kV, 11kV and 6.6kV.

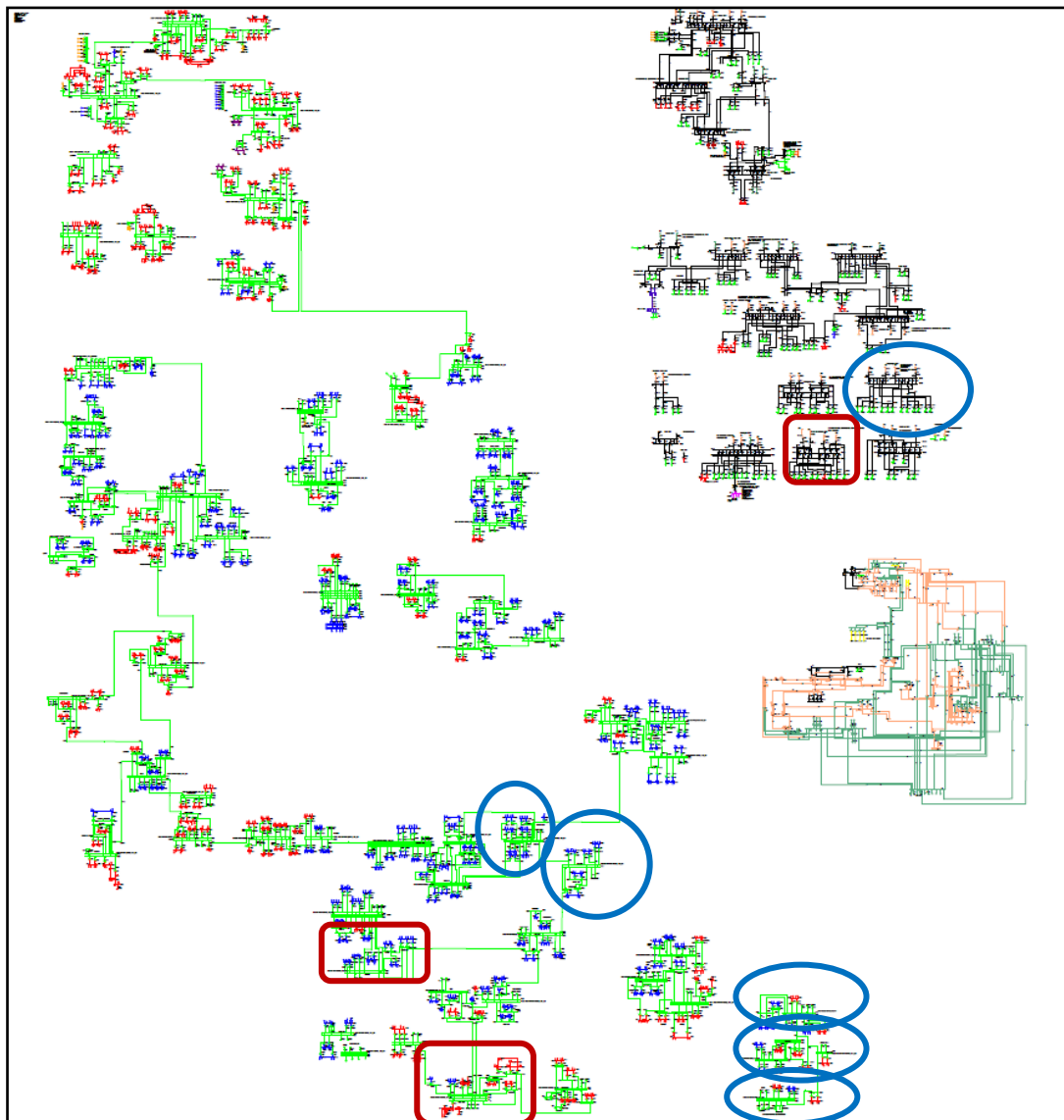

Figure 13: The whole ENWLEHV network in IPSA model

In this study two initial subnetworks are selected. They are (i) South Manchester GSP as the first studied subnetwork marked with the red boxes as shown in figure 13, and (ii) Staybridge GSP as the second studied substations marked in blue cycles as shown in figure 13. The detailed parameters of the two subnetworks are given in Table 6.

Table 6: Parameters of two selected subnetworks

Aspects \ Networks	First Network	Second Network
GSP Name	South Manchester GSP	Stalybridge GSP
No. of BSP	2	6
Names of BSP	Moss Nook; Stretford	Buxton; New Mills; Heyrod; Stuart Street; Droylsden; Hyde
No. of Primary Substations	11	28
No. of Transformers	33	76
No. of Distribution Generators	5	0
Total Power Rating at the GSP	178.03MW 88.45MVar	434MW 235.61MVar
Average Power Factor at GSP	89.56%	87.88%
Total No. of Nodes	102	222

As it can be seen from table 6, the first subnetwork has two Bulk Supply Points (BSPs), 11 parallel transformers which can be used for the tap stagger operation and 5 generators. While the second subnetwork has 6 BSPs, 28 parallel transformers and no distribution generators. The first studied subnetwork is a medium-size network with the rating of 178 MW and 48MVar with DGs. The second studied subnetwork is the largest network with rating of 430 MW and 236MVA without DGs. They are selected for the reactive power absorption capability studies.

2.3.2 Network conversion

Since the original ENWL EHV network was given in IPSA model which is limited to power flow studies for network design and planning purpose. In order to cooperate the simulation of the network tap stagger operation method into the network modelling tool, an open-source network simulation tool, called Open DSS software [18], has been selected. As a result, IPSA network model has been converted OpenDSS model. The network conversion flow chart from IPSA model to Open DSS model is shown in Figure 14.

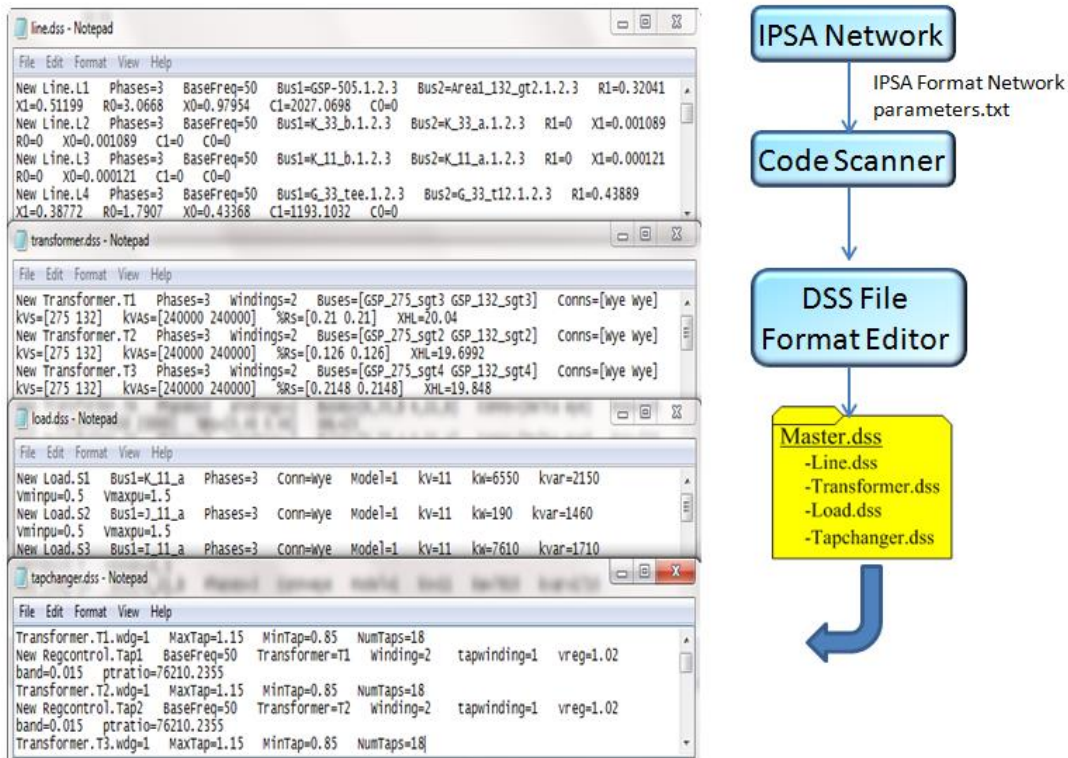

Figure 14: IPSA to OpenDSS Conversion Flow Chart

At the beginning, the original parameters of the selected subnetworks in IPSA model are saved to a text file. The code scanner was programmed in Matlab to convert all parameters of the IPSA network model to Open-DSS formats which can be read and run by Open-DSS software. This completed the network modelling tool conversion. The key contribution of the work in this stage is the programming of the code scanner in Matlab. It can scan any IPSA model and convert it into Open DSS model.

2.3.3 Testing and validation of the converted sub-networks

The selected two subnetworks have been converted from IPSA model to Open-DSS models. They are validated through the comparison of the voltage values on all buses under different load and optional conditions between IPSA and OpenDSS. The results of the comparison and validation for the South Manchester GSP subnetwork are given in Appendix 3. The comparison and validation results of Stalybridge GSP subnetwork with 222 substations/load centres are discussed in details.

2.3.3.1 Network voltage simulation and validation without AVC control

The Stalybridge GSP subnetwork in Open-DSS model was tested without Automatic Voltage Control (AVC) relay control of the transformer tap changers under different load conditions; They are: (i) at rated loads, or (ii) at half rated loads, or (iii) at 1.4 times rated loads. The errors of the voltage different between Open-DSS model and IPSA model are shown in Figure 15. Figure 15(a) shows the compared results at rated loading. Figure 15(b) shows the compared results at 0.5 and 1.4 rated loading, respectively.

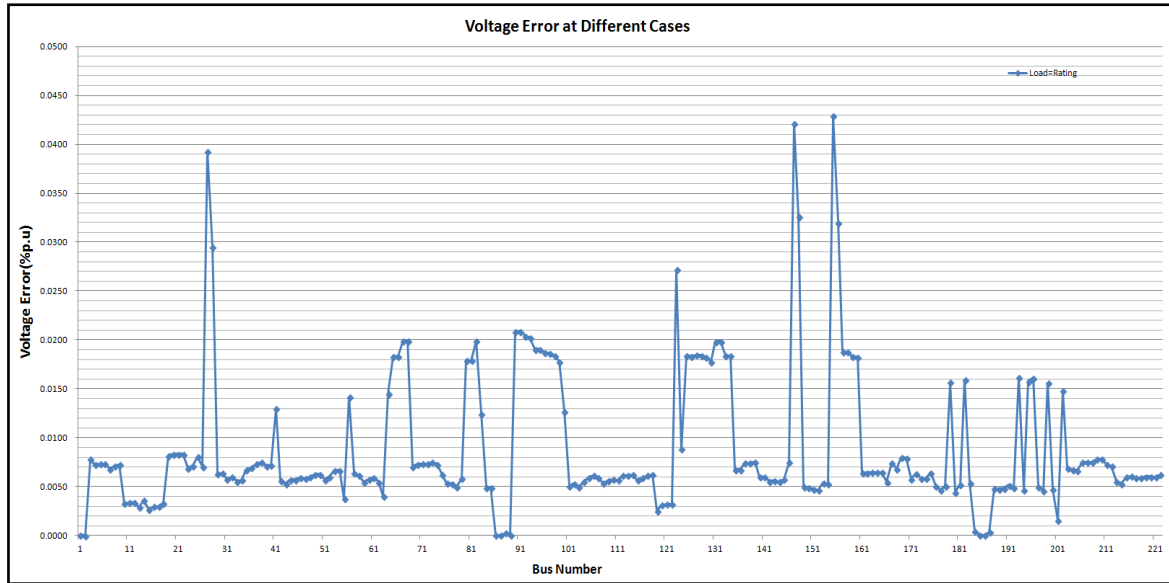

Figure 15(a): Voltage difference on all buses under the rated load conditions

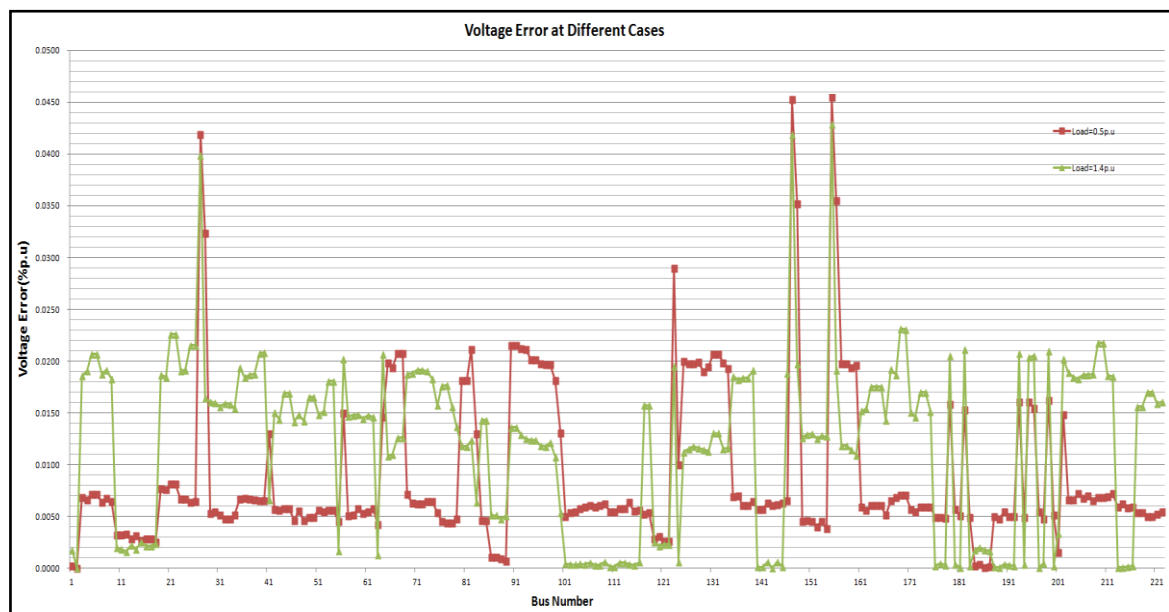

Figure 15(b): Voltage difference on all buses under 0.5p.u and 1.4 p.u load condition, respectively

As it can be seen from figure 5(a), the maximum and minimum voltage differences between network of Open-DSS model and IPSA Model are 0.0429% and 0.00001%, respectively. The average error on the all buses is 0.00888%, and the standard deviation is 0.00708%. Similarly, the result analysis of Figure 15(b) for two load conditions has also been conducted. The comparison results for all three load conditions are given in Table 7. Results show the difference between the converted Open-DSS model and the original IPSA model are very small.

Table 7: The statistic analysis results for 3 different scenarios

Statistic Analysis \ Load Value	1.0p.u	0.5p.u	1.4p.u
Mean Value (%)	0.00888	0.00887	0.01193
Standard Deviation (%)	0.00708	0.00770	0.00831
Maximum Value (%)	0.04290	0.04546	0.04285
Minimum Value (%)	0.00001	0.00000	0.00002

2.3.3.2 Network voltage simulation and validation with ACV control

The Stalybridge GSP subnetwork in Open-DSS model was tested with AVC relay control of the transformer tap changers under the rated load condition. Results are shown in Figure 16.

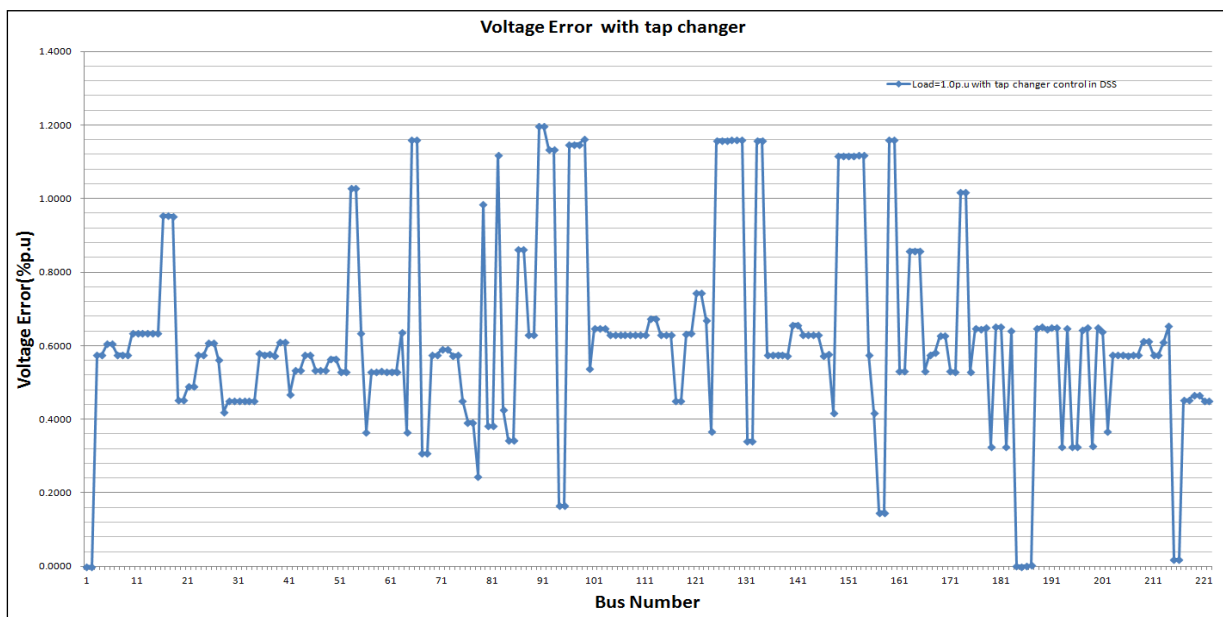

Figure 16: Validation results when AVC applies

As it can be seen from Figure 16, the maximum and minimum voltage differences/errors are 1.197% and 0.00001%, respectively. The average voltage error for all buses is 0.618%, and the standard deviation is 0.26455%. By comparing the results in Figure 16 with that in Figure 15(a), the total average voltage error of 0.618% in Figure 16 is much higher than that of 0.00888% in Figure 15(a). This may be explained that the AVC relay control algorithm parameter settings, such as the initial tap and inter-tap changing time delays, for controlling the transformer tap changer between Open-DSS model and IPSA model may be implemented differently within the dead band of 2%. This would lead to the larger voltage difference between Open-DSS and IPSA. Nevertheless, the comparison results in Figure 16 show the average error of 0.618% which should be considered a quite small in comparing with 1% measurement errors in most practical measurement devices.

2.3.3.3 Q absorption and P losses validation with tap stagger technique

In this testing and validation, the tap stagger technique was applied to a pair of parallel transformers at Buxton. The pair of the parallel transformers is on 33kv/11kv bus bars with the name of “Waters_33_t11/t12” and “Waters_11_a/b”, respectively. The overall rating load at the pair of parallel transformer 11kv side is 7.12MW and 3.24 MVar. The results of additional Q absorption and P losses under different tap staggers between IPSA and OpenDSS models are shown in table 8. The comparison results of additional Q and P between Open-DSS and IPSA models are plotted and shown in Figure 17.

Table 8: Additional Q absorption and P losses of the parallel transformers with tap stagger

33/11kV 23MVA Parallel Transformers Load at Rating 7.12MW 23MVar						
Tap Stagger Amount	Additional Q Absorption(MVar)		Additional P Loss(MW)		Voltage Variation (p.u.)	
	OpenDSS	IPSA	OpenDSS	IPSA	OpenDSS	IPSA
0	0	0	0	0	0	0
1	+0.0428	+0.043	+0.0028	+0.003	+0.00020	+0.00019
2	+0.1716	+0.174	+0.0071	+0.008	+0.00066	+0.00062
3	+0.3871	+0.390	+0.0152	+0.016	+0.00589	+0.00129
4	+0.6886	+0.695	+0.0275	+0.028	+0.00224	+0.00219
5	+1.0783	+1.088	+0.0432	+0.044	+0.00337	+0.00333

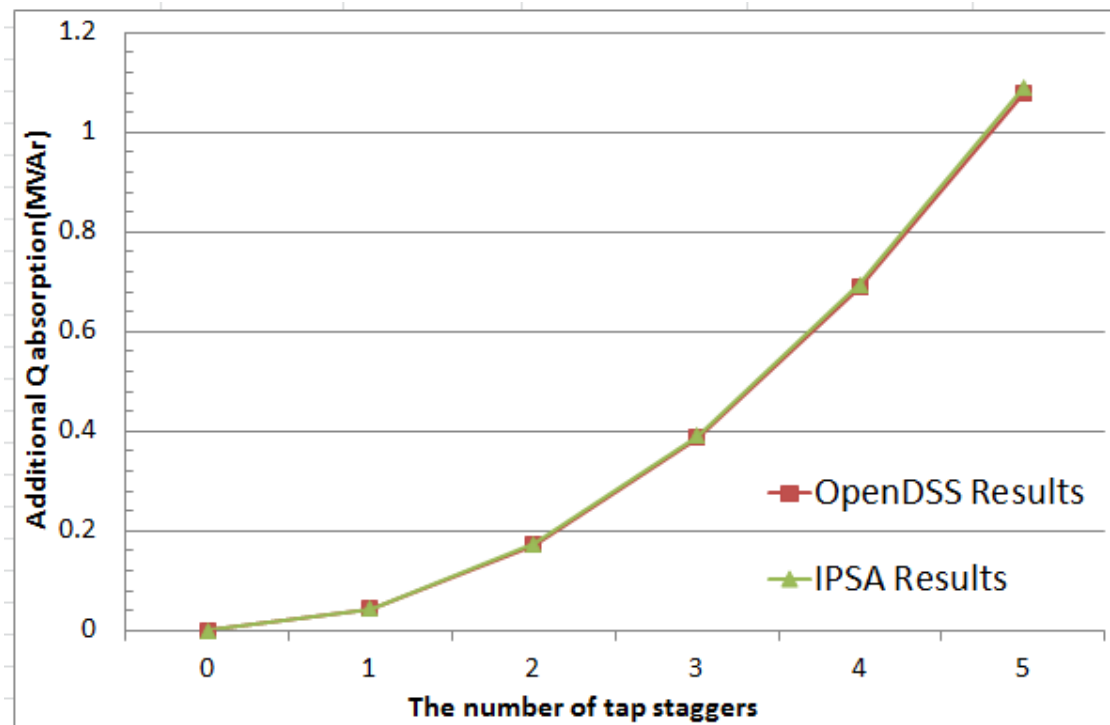

Fig.17(a): Additional reactive power absorption against the number of tap stagger

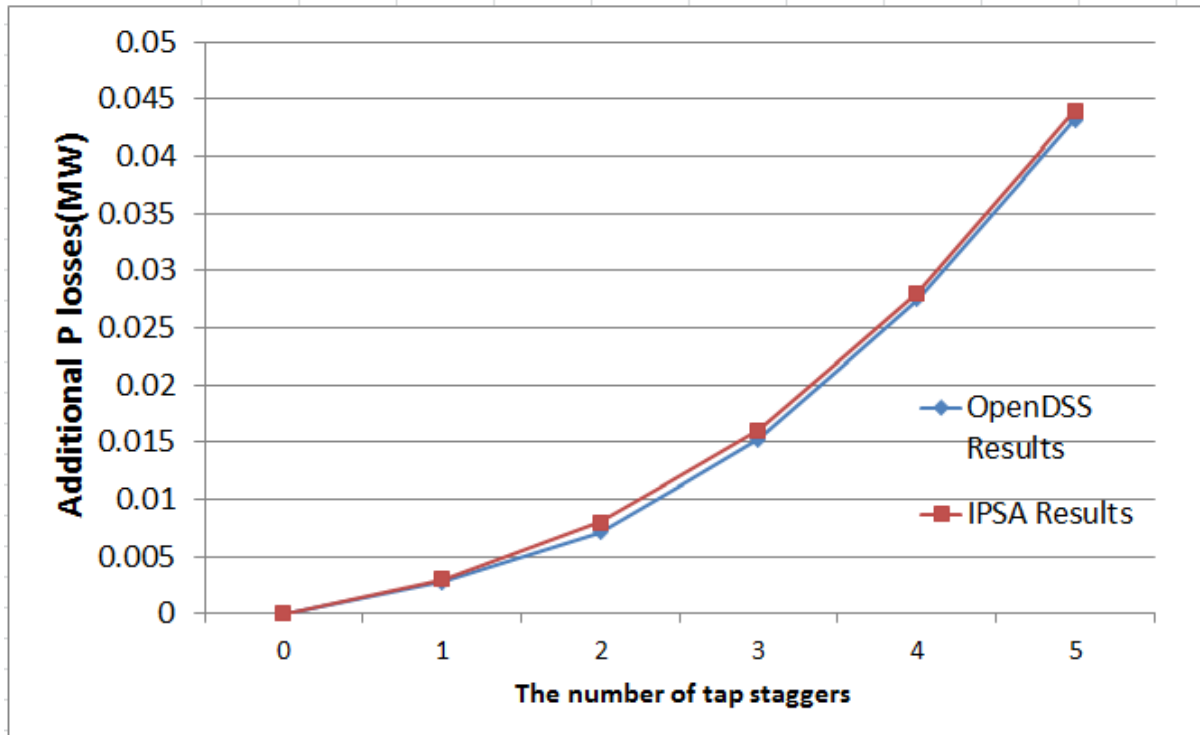

Fig.17(b):Active power loss against the number of tap stagers

Figure17: Comparison results of Q and P between Open-DSS and IPSA models under different number of tap stagers.

As shown in table 8 and plots in Figure 17, both the Q absorption and P losses between Open-DSS and IPSA models are very close to each other. However the additional Q absorption is significant from 0.428MVar to 1.078MVar, while the additional P loss has much smaller increase from 0.003MW to 0,043MW. The result also shows that the voltages at 11kV side remain unchanged. Similar tests have also been carried out for other primary transformers in the distribution network model. All comparison results and analysis confirm the tap stagger technique can provide additional reactive power Q absorption to support NG transmission networks

In summary the results from the testing and validation analysis confirm that the converted Open-DSS can be used for the project reactive power absorption capability studies.

2.4 Matrix/Dashboard Table Based Tap Staggering Control Method

2.4.1 Introduction

Tap staggering is one of CLASS techniques to provide an ancillary service of reactive power absorption to support transmission systems. There are many different tap stagger control methods. According to the literature review, the tap stagger control methods can be categorized into two.

- (i) Matrix/dashboard look up table search methods based on off-line power flow studies
- (ii) On line tap stagger control methods based on online monitoring and optimization calculations

The former matrix/dashboard method considers off-line power flow studies to establish reactive power absorption and real power loss capability database for all possible parallel transformers tap stagger

operational conditions under all possible generation and load conditions. The advantage of this method is simple and can be easily implemented without the need of sophistic close loop monitoring and control systems. However as on-line database calculation may not exhibit the actual network operation conditions, this method can only achieve a very rough guidance for the network tap stagger controllers or the network operators to manually operate a number of pairs of parallel transformers step by step until the required Q absorption will be met. In contrast the on-line tap stagger control methods not only can determine the optimal pair of parallel transformers to fulfill the required VAR absorption support, but also ensure that the voltage will stay within statutory limits and the real power will be kept to minimum.

2.4.2 Establishment of matrix database/dashboard look up table

At this stage, the matrix method for operating the tap stagger of parallel transformers for South Manchester GPS subnetwork has been implemented and simulated in Open-DSS model. The amount of the additional Q absorption and P losses from each pair of parallel transformers is dependent mainly on two factors: (i) the parallel transformer LV side load condition, and (ii) the permissible number of tap staggers operation by each pair of parallel transformers. To establish the database matrix for additional Q absorption and P losses, the following assumptions have been made:

- Assuming the each substation loading in per unit value delivering from the given real loading value over its own rated value,
- Assuming the fixed loading power factor delivering from the given rated P and Q on this loading node,
- Assuming no consideration of the thermal issues for the cables and transformers and other network equipment under the exceeding their rated power conditions.

The South Manchester GSP subnetwork with all 11 pairs of parallel transformers in operation of up to 4 tap staggers under different loading conditions was simulated in Open-DSS model. Results are listed in table 9.

Table 9. The matrix database for additional Q absorption and P losses in South Manchester GSP subnetwork during the tap stagger operation under different loading conditions

Pairs Parallel Transformers	1							
	1		2		3		4	
Tap Staggers	Q	P	Q	P	Q	P	Q	P
Loadings p.u.	KVAr	kW	KVAr	kW	KVAr	kW	KVAr	kW
....	-	-	-	-	-	-	-	-
1.2	-	-	-	-	-	-	-	-
1.1	61.46	2.29	246.08	9.16	554.63	20.64	988.39	36.77
1	60.20	2.23	241.03	8.93	543.24	20.12	968.21	36.01
0.9	59.35	2.21	237.62	8.83	535.54	19.90	954.31	35.46
0.8	58.75	2.19	235.23	8.75	530.14	19.72	944.67	35.13
....	-	-	-	-	-	-	-	-
Pairs Parallel Transformers	2							
	1		2		3		4	
Tap Staggers	Q	P	Q	P	Q	P	Q	P
Loadings p.u.	kVAr	kW	KVAr	kW	kVAr	kW	kVAr	kW
....	-	-	-	-	-	-	-	-

1.2	-	-	-	-	-	-	-	-
1.1	58.80	3.89	235.78	15.40	531.63	34.61	947.54	61.63
1	57.72	3.85	231.43	15.28	521.79	34.36	929.95	61.20
0.9	57.00	3.84	228.51	15.27	515.19	34.35	918.14	61.22
0.8	56.51	3.83	226.49	15.26	510.61	34.36	909.93	61.25
....	-	-	-	-	-	-	-	-
Pairs Parallel Transformers	3							
Tap Stagers	1		2		3		4	
Loadings p.u.	Q kVAr	P kW	Q KVAr	P kW	Q kVAr	P kW	Q kVAr	P kW
....	-	-	-	-	-	-	-	-
1.2	-	-	-	-	-	-	-	-
1.1	47.78	5.83	195.02	21.88	442.17	48.28	790.02	85.18
1	46.91	5.74	191.09	21.75	432.99	48.14	773.35	85.09
0.9	46.35	5.68	188.48	21.71	426.81	48.21	762.07	85.35
0.8	45.99	5.62	186.69	21.67	422.51	48.26	754.14	85.58
....	-	-	-	-	-	-	-	-
Pairs Parallel Transformers	4,5,6...11							
Tap Stagers	1		2		3		4	
Loadings p.u.	Q kVAr	P kW	Q KVAr	P kW	Q kVAr	P kW	Q kVAr	P kW
....	-	-	-	-	-	-	-	-

As it can be seen from table 9, for the first pair of transformer, the Q absorption and P loss under 1 tap stagger at rating load level are 60.2kVAr and 2.23kW, respectively, while they increase to 968kVAr and 36kW when the tap stagers change to 4. Similarly the capability of the pair of 2, 3 ... 11 of parallel transformers under different tap stagger and load conditions are also listed in the matrix database table 9.

2.4.3 Matrix database/dashboard lookup table search method

After the matrix database / dashboard look up table are established, the tap stagger control search method (as shown in Fig.12) takes the inputs of the network state conditions, including busbar voltage, bus loading conditions and transformer tap position, from the state estimator and the request of the amount of Q absorption requirement from NG control center, it then carries out the search from the matrix database to determine the number of pair of transformers and the number of tap stagers will be required to satisfy the Q absorption required at the South Manchester GSP by NG network. The search to look up matrix database table can be done manually or automatically. The former is much simpler, but it is very hard to achieve good match the exact amount of Q absorption support to the South Manchester GSP by NG. The later automatic search method in cooperation with optimization algorithm can achieve much better match results as the optimization search method can determine the most proper tap stagger solution at the minimum power loss. However it will be much more complicate and expensive to implement. The automatic database tap stagger search method has been implemented and the flow chart of the method is shown in Figure 18.

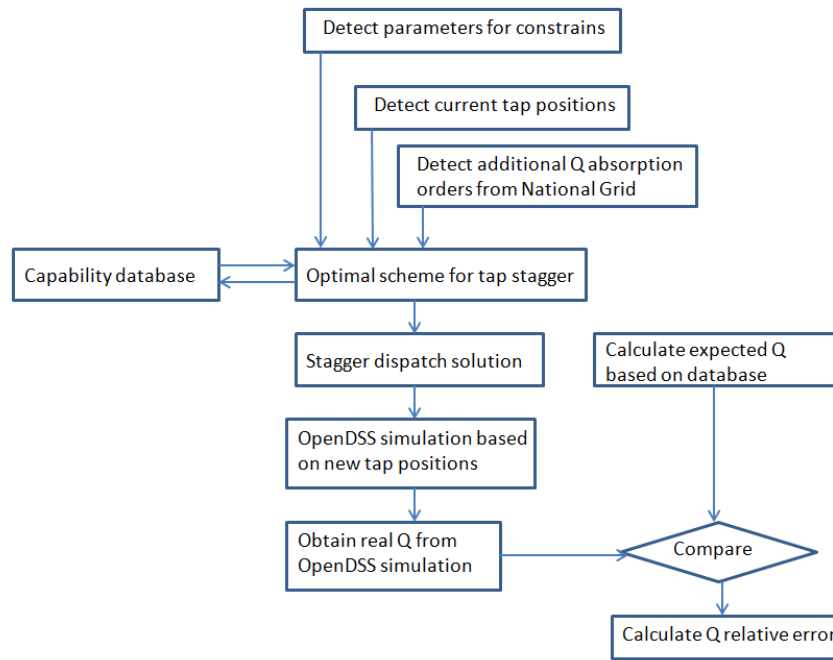

Figure 18: The flow chart of the implemented optimal tap stagger search method

As in Figure 18, the method takes the inputs of tap positions, the maximum number of the tap stagers, and the required Q absorption amount from NG, then to carry out the search from the established matrix database. The tap position of each pair of the parallel transformers indicate if the pair has any tap up or down room for the tap staggering operation. The tap stager number constraints are considered to prevent any potential overloading of the pair of the parallel transformer during the tap staggering operation. The CLASS specifies the permissible tap stager number is up to 4 tap staggering operations.

Two case studies with assuming the request of Q absorption from South Manchester GSP by NG of 1MVar and 2MVar, respectively, are considered and load equals to 1.0p.u. The tap stager number constraints are set at 2. The simulation results of reactive power absorption and power losses are shown in Figure 19 and 20, respectively.

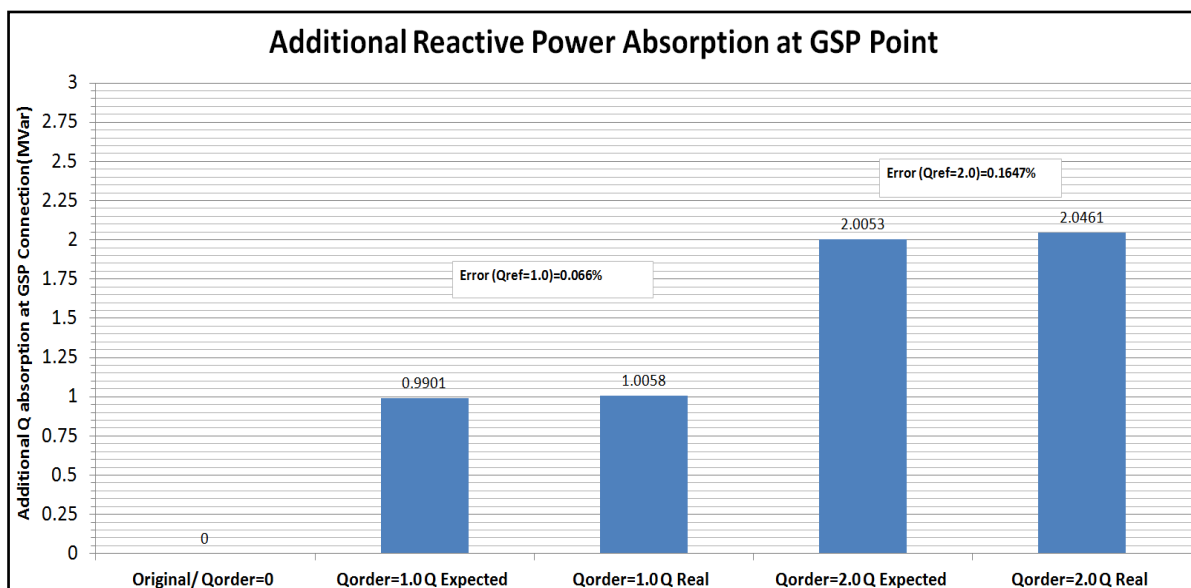

Figure 19 Q changes at the power source point due to tap staggering

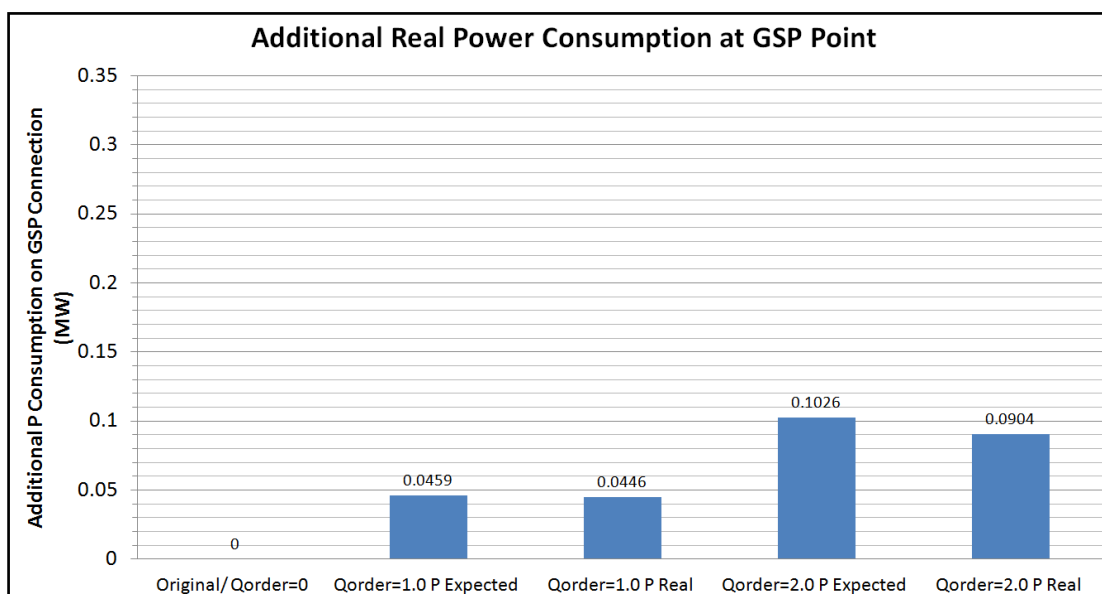

Figure 20: P changes at the power source point due to tap staggering

Figure 19 and 20 show Q absorption and P losses at the South Manchester subnetwork GSP were obtained for two different requests at 1MVar and 2MVar, respectively. There are two Q absorption and P loss results. One is the 'expected value' and the other is actual value. The expected value means the values should be obtained according to the summation of Q absorption and P losses data for the involved pairs of the parallel transformers and their tap stagger numbers in the matrix database, while the real value represents the simulation results through OpenDSS model as shown in Figure 12. As shown there are small difference between the expected value and actual simulation value by the search method.

As it can also be seen from Figure 18 and 19, there is no additional Q and P losses when no tap staggering operation. The Q absorptions give 1.0058MVar and 2.064MVar in corresponding to the request of 1MVar and 2MVar, respectively. The P losses 0.0446MW and 0.09MW in corresponding to the tap staggering operations to support 1MVar and 2MVar, respectively, to the South Manchester subnetwork GSP.

This work confirms it is feasible to use matrix database/dashboard loop up table search method to provide the calculation for the reactive power support to ENWL network GSPs connecting to NG transmission networks.

2.5 ENWL Network Q Absorption Capability Studies

2.5.1 ENWL EHV network model

In this report of Part B, the whole ENWL network (as shown in Figure 21) reactive power absorption capability during the application of tap staggering operation of parallel transformers has been investigated and simulated.

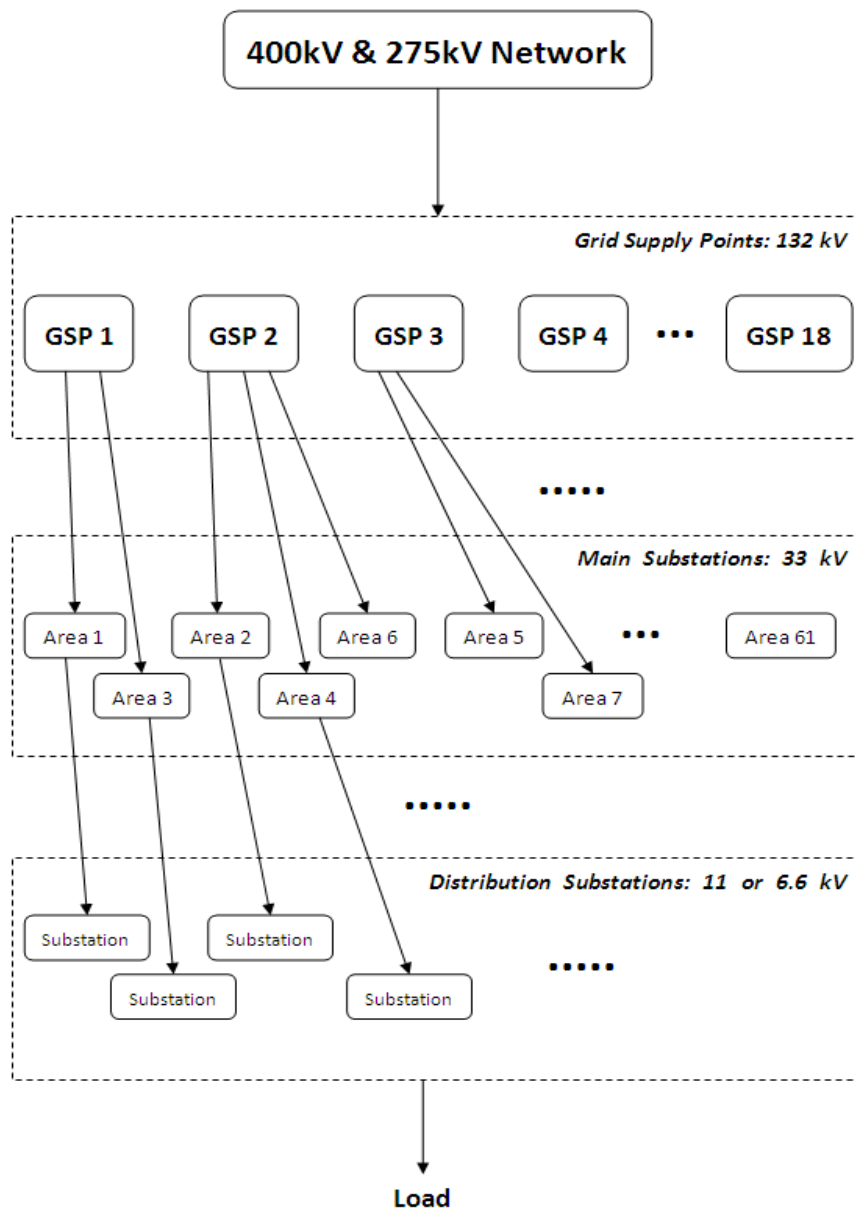

Figure21: The whole ENWL EHV networks

2.5.2 ENWL reactive power absorption capability estimation

The network shown in Figure 21 can be divided into 18 GSP and 61 areas. The networks have 178 pairs of 33/11kV parallel transformers and 177 pairs of 33/6.6kV parallel transformers to form the total 354 pairs of parallel transformers. Refer to section 2.3, the reactive power absorption capability studies are considered for the selected two subnetworks of “South Manchester GSP” and “Stalybridge GSP”. The results under maximum 4 tap stagger limits are shown in table 10 and 11, respectively.

Table 10. Results of the additional Q absorption and P losses against to the number of tap stagers for the studied South Manchester GSP subnetwork

South Manchester GSP subnetwork consisting of 11 pairs of parallel transformers and 102 load buses					
Allowed Maximum Stagger Amount	original	1	2	3	4
P at 400kV Point (MW)	164.6614	164.698	164.801	164.971	165.208
Q at 400kV Point (MVA _r)	10.1624	10.7661	12.585	15.6134	19.8431
Additional P losses (MW)	0	0.0364	0.1397	0.3096	0.5462
Additional Q absorption (MVA _r)	0	0.6037	2.4226	5.451	9.6807
P losses per primary sub(MW/Sub)	0	0.00331	0.0127	0.028145	0.04965
Q absorbed per primary sub(MVA _r /Sub)	0	0.05488	0.22024	0.495545	0.88006

Table 11. Results of the additional Q absorption and P losses against the number of tap stagers for the studied Stalybridge GSP subnetwork

Stalybridge GSP subnetwork consisting of 28 pairs of parallel transformers and 222 load buses					
Allowed Maximum Stagger Amount	original	1	2	3	4
P at 400kV Point (MW)	433.64	433.746	434.041	434.5247	435.143
Q at 400kV Point (MVA _r)	208.664	210.408	215.356	223.4832	233.842
Additional P losses (MW)	0	0.1057	0.401	0.8847	1.5029
Additional Q absorption (MVA _r)	0	1.744	6.6923	14.8192	25.1776
P losses per primary sub (MW/Sub)	0	0.00378	0.01432	0.031596	0.05368
Q absorbed per primary sub(MVA _r /Sub)	0	0.06229	0.23901	0.529257	0.8992

As can be seen from table 10, the additional Q absorption for all 11 pairs of parallel to operate at one tap stager is 0.6037MVA_r. The reactive power absorption ability will increase to 9.68 MVA_r for all 11 pairs of parallel transformers to operate at 4 tap stagers. Similarly it can be read from table 11, the additional Q absorption for all 28 pairs of parallel to operate at one tap stager is 1.744MVA_r. The reactive power absorption ability has increased to 25.18MVA_r for all 28 pairs of parallel transformer to operate at 4 tap stagers. From both table 10 and 11, the P losses for all pair of transformers to operate tap stagers are about 16 times smaller than Q absorption capability.

If consider that all pair of parallel transformers will contribute to the reactive power absorption to the corresponding the network GSP can be estimated based on the South Manchester subnetwork Q absorption capability studies, the total 354 pairs of parallel transformers in the whole ENWL network can be estimated and the results are shown in table 12.

Table 12. Estimated Q absorption Capability in the whole ENWL network based on the studies of south Manchester GSP subnetwork.

Estimated Q Absorption Capability for the whole ENWL network based on South Manchester GSP subnetwork study					
Allowed Maximum Stagger Amount	original	1	2	3	4
P loss across ENWL(MW)	0	1.17142	4.4958	9.963491	17.5777
Q Capability across ENWL(MVA _r)	0	19.4282	77.9637	175.4231	311.543

Similarly based on the Stalybridge GSP subnetwork Q absorption capability studies, the total 354 pairs of parallel transformers in the whole ENWL network can be estimated and the results are shown in table 13.

Table 13. Estimated Q absorption Capability in the whole based on the studies of Stalybridge GSP subnetwork.

Estimated Q Absorption Capability for the whole ENWL network based on Stalybridge GSP subnetwork study					
Allowed Maximum Stagger Amount	original	1	2	3	4
P loss across ENWL(MW)	0	1.33635	5.06979	11.18514	19.001
Q Capability across ENWL(MVAr)	0	22.0491	84.6098	187.357	318.317

By comparing the estimated the whole Q absorption capabilities based on the studies between two GSP sub-networks, South Manchester and Stalybridge, the results are close to each other in in spite of the two different sizes of subnetworks and different loading conditions. If consider to apply an average data method for the results from table 12 and 13, we can obtain the average estimated the whole ENWL reactive power absorption capability as shown in table 14.

Table 14. The averaging estimated Q absorption capability in the whole based on the studies of both selected GSP subnetworks.

Averaging the Estimated Q Absorption Capability based on the Two Sub-Networks studies					
Allowed Maximum Stagger Amount	original	1	2	3	4
P loss across ENWL(MW)	0	1.25388	4.78279	10.57431	18.2893
Q Capability across ENWL(MVAr)	0	20.7387	81.2867	181.3901	314.93

The comparison between the results in table 12, 13 and 14 are plotted in Figure 22.

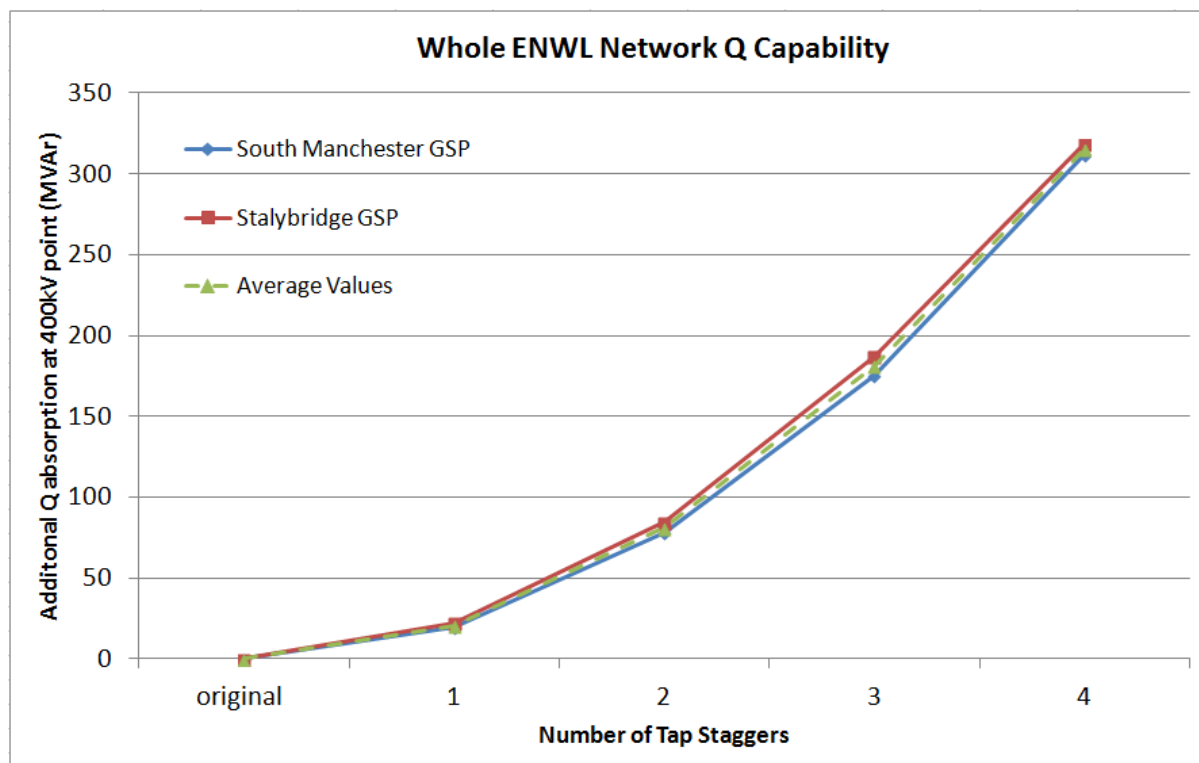

Figure 22. The comparison results between the averaging estimation and the actual estimated reactive power absorption capability of South Manchester and Stalybridge GSPs.

Results show that the additional Q absorption for all 354 pairs of parallel transformers to operate at one tap stagger is 20.7MVar. The reactive power absorption ability will increase to 81.3 MVar for all 354 pairs of parallel transformers to operate at 2 tap staggers; 181.4MVar at 3 tap staggers and 314.93 MVar at 4 tap staggers.

Although in the studies, 4 maximum tap staggering constraints are assumed, in practice each pair of parallel transformer tap position will be determined by the load flow operation conditions. In some cases, the pair of parallel transformers may be limited to operate 1 or even 0 tap staggers to their tap reference position at highest or lowest load flow conditions, hence the overall capability across the whole ENWL EHV distribution network should be smaller than the estimated results.

2.6 Conclusions - Part B

This report of part B has detailed the methodology how to operate tap stages on a number of pair of parallel transformers to provide a required reactive power support for National Grid transmission networks using the existing ENWL distribution reactive power absorption capability. Due to the very large of ENWL EHV distribution networks, two sub-networks named as “South Manchester GSP” and “Stalybridge GSP” were selected and modelled into Open-DSS model, so that the tap staggering control method can be in-cooperated into the Open-DSS network model for the network reactive power absorption capability studies.

The modelled Open-DSS network has been evaluated, compared and validated. The matrix database for tap stagger control search method has been designed and implemented. The method has been applied to the converted South Manchester network Open DSS model. The results were examined and analysed. The correctness of the tap staggering operation has been tested and analysed. Results confirm the studied “Stalybridge GSP subnetwork” is able to provide the required reactive power support at GSP for GN transmission networks.

Finally, the Q absorption capability of both South Manchester and Stalybridge networks under 4-stagger tap operations constraints were simulated and analyzed. By considering the averaging data methods, the estimation of the whole ENLW network reactive power absorption capability have been carried out.

In conclusion, the key outcome of WP2- Part B has been achieved by providing the analysis methodology, developing matrix database tap stagger control search method and estimating the ENWL EHV network reactive power absorption capability. Future work will focus on the development of real-time tap staggering control optimisation method. The effectiveness and capability of tap stagger techniques will be tested and improved though the validation and analysis against the measurements from ENLW CLASS trials.

3 References

- [1] "Modelling and aggregation of loads in flexible power networks," 2014.
- [2] J. V. Milanović, "On unreliability of exponential load models," *Electric Power Systems Research*, vol. 49, no. 1, pp. 1-9, 2/15/ 1999.
- [3] L. M. Korunovic, D. P. Stojanovic, and J. V. Milanovic, "Identification of static load characteristics based on measurements in medium-voltage distribution network," *Generation, Transmission & Distribution, IET*, vol. 2, no. 2, pp. 227-234, 2008.
- [4] B. Andrea and O. L. Nando, "Initial Assessment of Voltage Led Demand Response from UK Residential Loads," in *IEEE/PES Innovative Smart Grid Technologies (ISGT) 2015*. Washington DC, 2015.
- [5] ELEXON, "Load Profiles and their use in Electricity Settlement," 2013.
- [6] T. S. o. State, "The Electricity Safety, Quality and Continuity Regulations 2002," *S T A T U T O R Y I N S T R U M E N T S*, 2002.
- [7] R. Ian, "Integrated high-resolution modelling of domestic electricity demand and low voltage electricity distribution networks," Doctor of Philosophy dissertation, Electronic, Electrical and Systems Engineering, Loughborough University, 2011.
- [8] I. Richardson and M. Thomson, "Domestic electricity demand model - simulation example," 2010.
- [9] Electricity North West. LV Network Solutions. [Online]. Available: <http://www.enwl.co.uk/about-us/the-future/lcnf-tier-1-projects/low-voltage-network-solutions>
- [10] ENWL. Low Voltage Network Solutions. [Online]. Available: <http://www.enwl.co.uk/about-us/the-future/lcnf-tier-1-projects/low-voltage-network-solutions>
- [11] B. Andrea, O. L. Nando, and T. Victoria, "A Monte Carlo Assessment of Customer Voltage Constraints in the Context of CVR Schemes," in *CIREN 23rd International Conference on Electricity Distribution*. Lyon, 2015.
- [12] "Code of Practice 382 Transformer Ratings," *Electricity North West*, 2009.
- [13] R. C. Dugan and T. E. McDermott, "An open source platform for collaborating on smart grid research," in *Proc. 2011 Power and Energy Society General Meeting, 2011 IEEE*, pp. 1-7.
- [14] "Code of Practice 370 Voltage control for 132/33/11/6.6kV Systems," *Electricity North West*, 2009.
- [15] A. Shukla, R. Tiwari, and R. Kala, *Towards Hybrid and Adaptive Computing: A Perspective*, Springer-Verlag Berlin Heidelberg, 2010
- [16] Electricity user load profiles (daily) by profile class, Energy Data Centre, UKERC, 1997. [Online]. Available: <http://data.ukedc.rl.ac.uk/browse/edc/Electricity/LoadProfile>
- [17] IPSA Power, "A comprehensive software product for the design, operation and analysis of Electrical Power Systems " http://www.ipsa-power.com/software_referenced on January 2015
- [18] EPRI, "Open DSS - a comprehensive electrical power system simulation tool primarily for electric utility power distribution systems", <http://smartgrid.epri.com/SimulationTool.aspx>, referenced on January 2015

Appendix 1 South Manchester Network from ENW

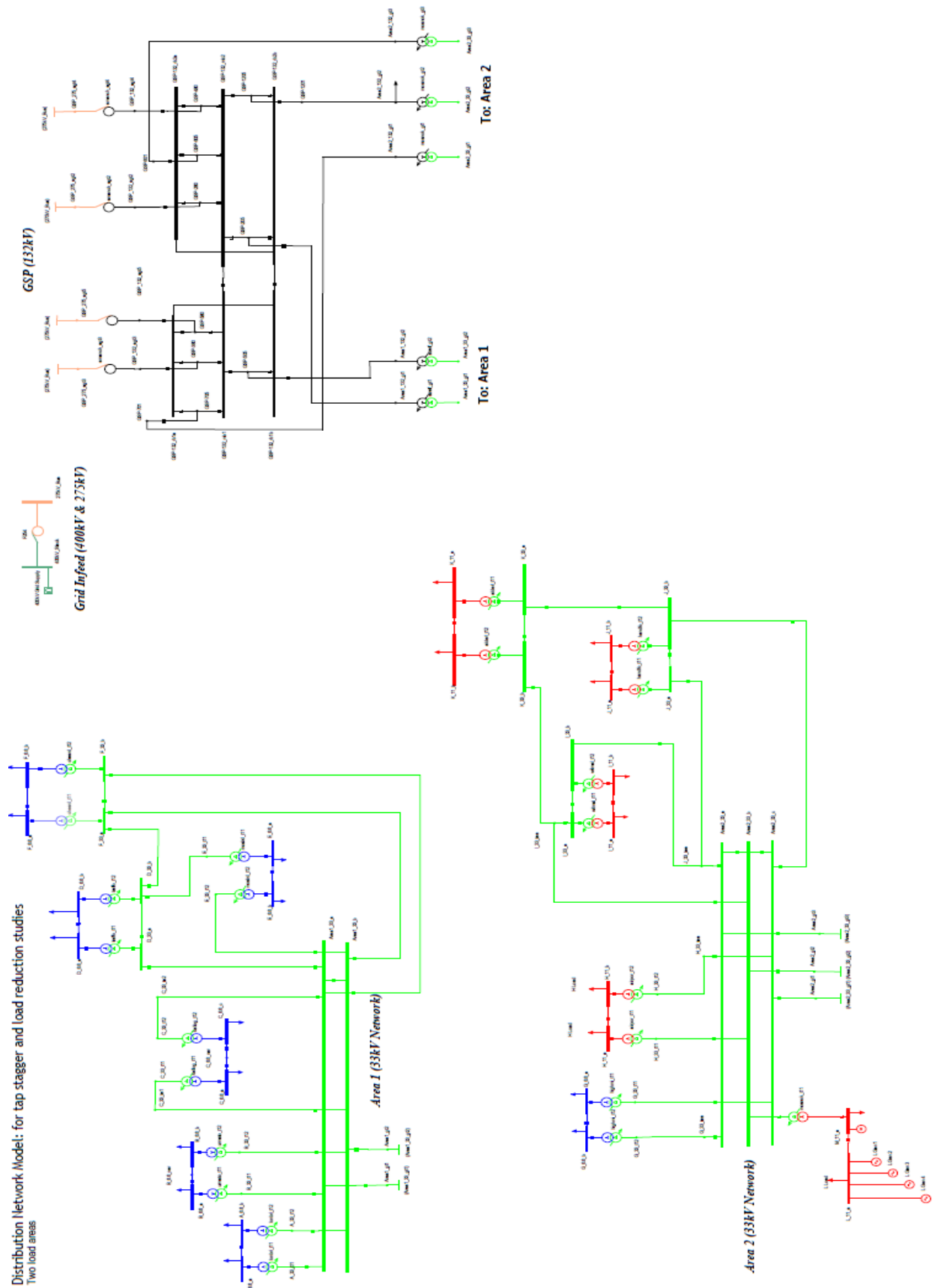

Appendix 2 Stalybridge Network from ENW

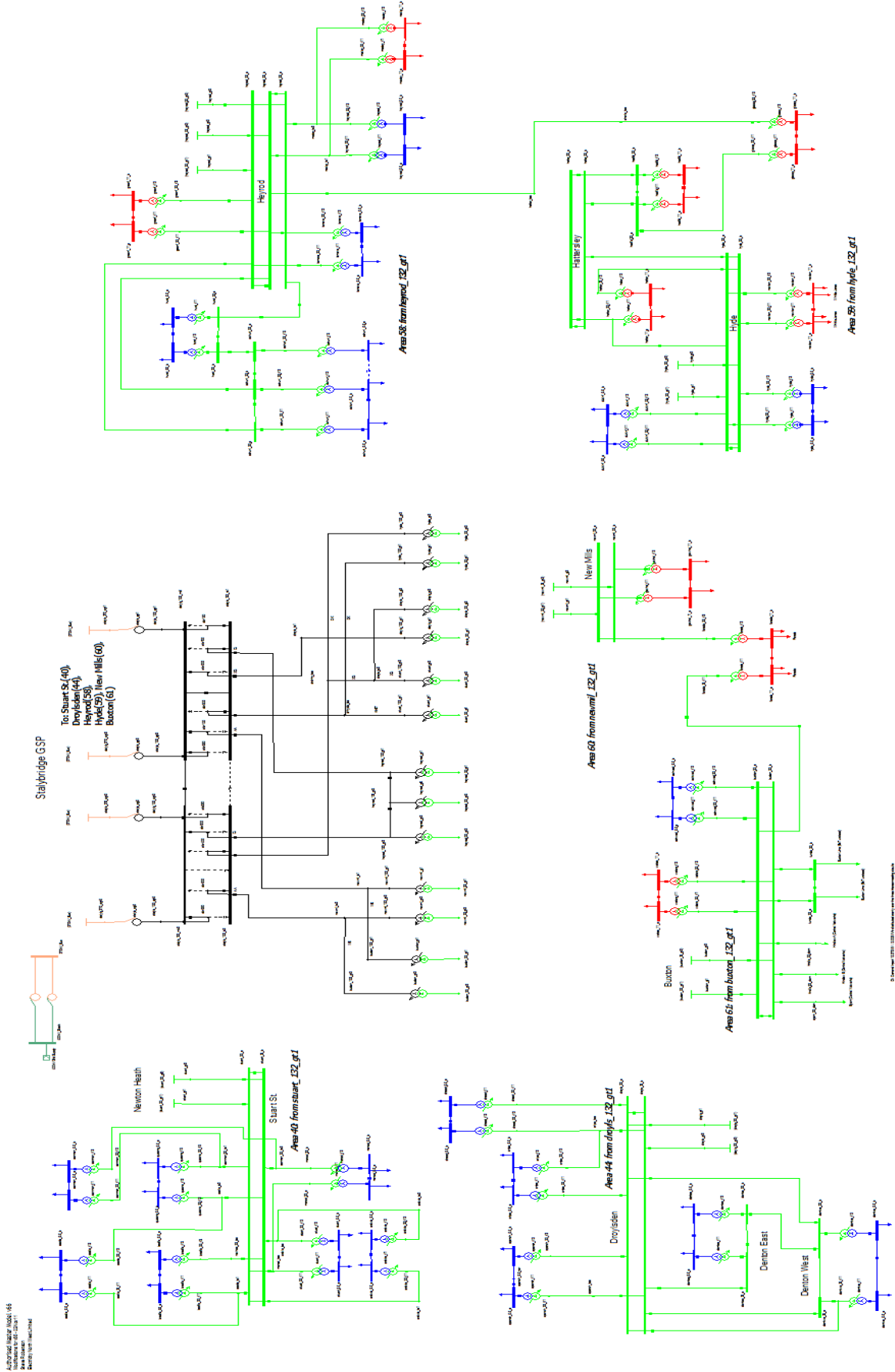

Approved Master Model 165
16/01/2015
16/01/2015
16/01/2015

Appendix 3 The Validation Results for the First Open-DSS Converted Network

The OpenDSS model has been tested under the following cases:

Case 1: The IPSA network operating without AVC Real control. The tap positions are set at the same for both OpenDSS and IPSA models. The results from case 1 are used as a base line for the comparison purpose for both case 2 and case 3.

Case 2: Distributed generators of total 23.8MW are connected to the grid and the reactive power generation is zero.

Case 3: Based on Case 2, the network load increases by 50% of its initial consumption.

Case 4: The network is operated with AVC relays that maintain the secondary voltages of primary substations. The target voltage of each AVC relay is the same as the one in the IPSA.

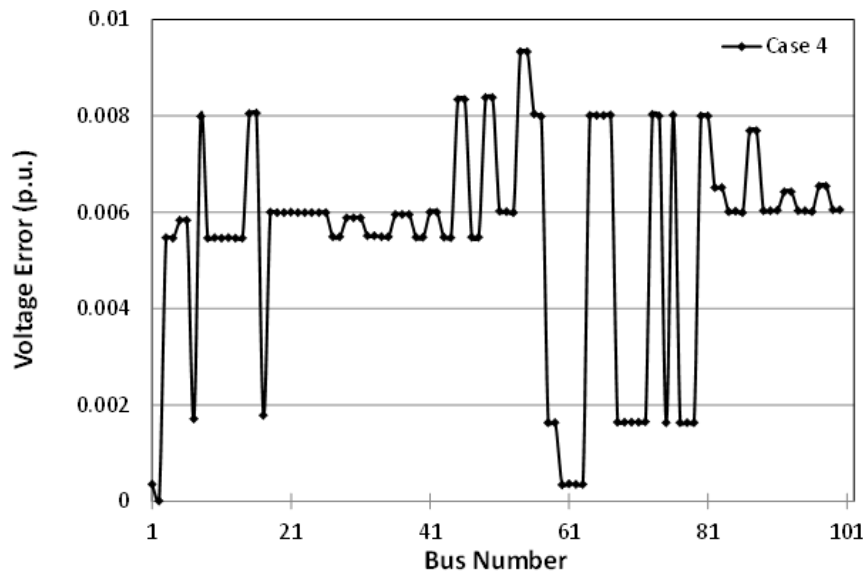
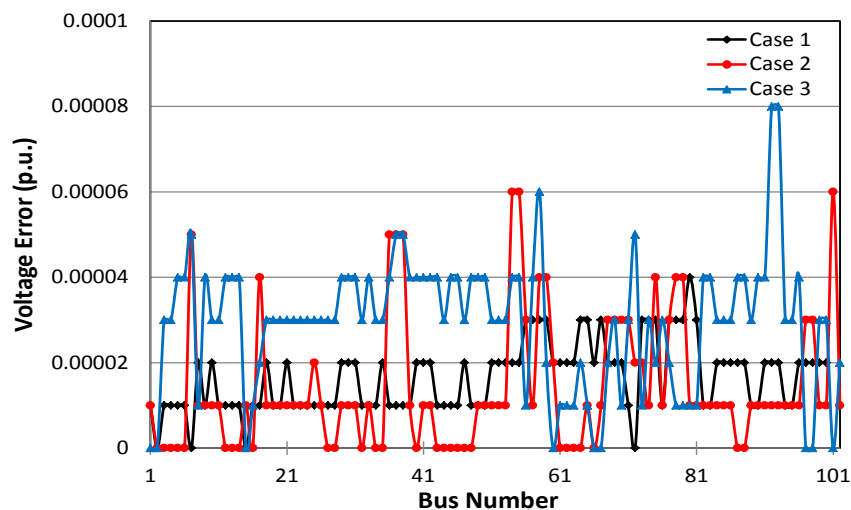

Voltage errors (pu)	Case 1	Case 2	Case 3	Case 4
Maximum	0.00004	0.00006	0.00008	0.00933
Average	0.000016	0.000014	0.000029	0.005488
Standard Deviation	0.000008	0.000015	0.000016	0.002312

Validation on parallel transformer tap stagger:

33/6.6 kV Parallel Transformers with Rating = 23 MVA				
Tap steps apart	Additional Q_{absorbed} (MVar)		Additional P_{loss} (MW)	
	OpenDSS	IPSA	OpenDSS	IPSA
0	0	0	0	0
2	0.0449	0.045	0.0018	0.001
4	0.1796	0.18	0.0072	0.006
6	0.4046	0.405	0.0162	0.016
8	0.7203	0.721	0.0287	0.028
10	1.1275	1.128	0.0451	0.044
12	1.6274	1.628	0.0651	0.065

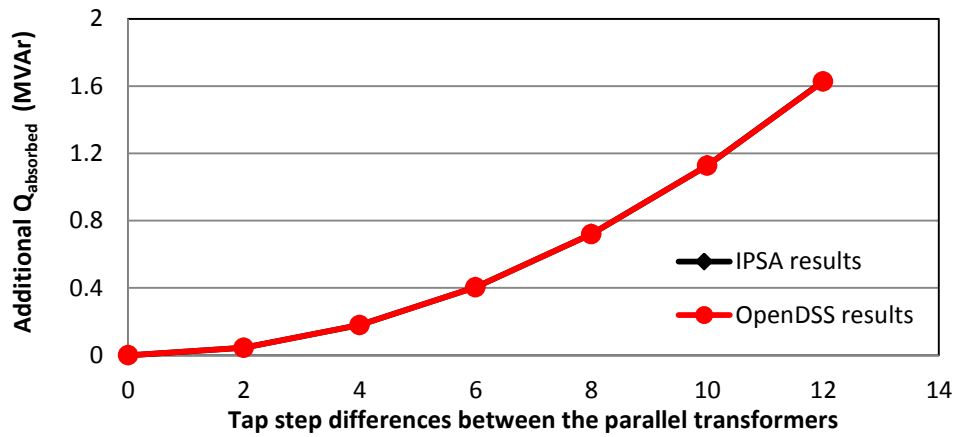

(a) Additional reactive power absorption of the transformers

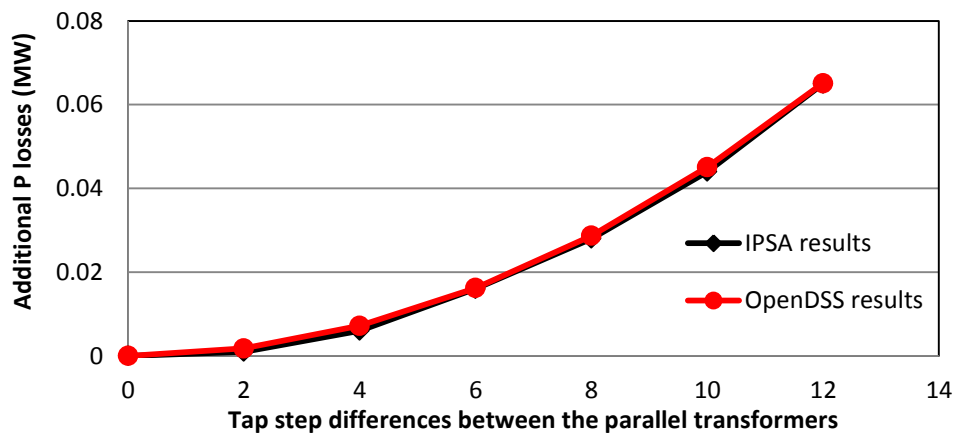

(b) Additional active power losses of the transformers