



Data-driven system identification and control of home facilities for comfortable, energy cost effective and safe home

DOI:

[10.1109/icac61394.2024.10718751](https://doi.org/10.1109/icac61394.2024.10718751)

Document Version

Accepted author manuscript

[Link to publication record in Manchester Research Explorer](#)

Citation for published version (APA):

Yang, Z., & Zhang, L. (2024). Data-driven system identification and control of home facilities for comfortable, energy cost effective and safe home. In *2024 29th International Conference on Automation and Computing (ICAC)* IEEE. <https://doi.org/10.1109/icac61394.2024.10718751>

Published in:

2024 29th International Conference on Automation and Computing (ICAC)

Citing this paper

Please note that where the full-text provided on Manchester Research Explorer is the Author Accepted Manuscript or Proof version this may differ from the final Published version. If citing, it is advised that you check and use the publisher's definitive version.

General rights

Copyright and moral rights for the publications made accessible in the Research Explorer are retained by the authors and/or other copyright owners and it is a condition of accessing publications that users recognise and abide by the legal requirements associated with these rights.

Takedown policy

If you believe that this document breaches copyright please refer to the University of Manchester's Takedown Procedures [<http://man.ac.uk/04Y6Bo>] or contact openresearch@manchester.ac.uk providing relevant details, so we can investigate your claim.



Data-driven system identification and control of home facilities for comfortable, energy cost effective and safe home

Zhenyi Yang
School of Engineering
University of Manchester
Manchester, UK

zhenyi.yang-4@postgrad.manchester.ac.uk

Long Zhang
School of Engineering
University of Manchester
Manchester, UK

long.zhang@manchester.ac.uk

Abstract—Modern homes use a large number of apparatus and they are not coordinately controlled in their maximal performance. Therefore, the room temperature may not be steady enough. Additionally, energy costs may be high due to increased electricity prices during peak demand periods. In addition, the use of the facility may have fire risk, the alarm only has the function of issuing an alarm, and the processing of the alarm source is still dependent on human operation, such as turning off the power or gas. In this paper, we proposed a control system based on data-driven system identification for multiple home apparatus to control the room temperature more stable, shift the load of the refrigerator while maintaining the refrigerator function, and connect the alarm to the control system, so that it can automatically cut off the alarm source. Extensive results show that the system can effectively stabilize room temperature, reduce electricity costs, and automatically cut off the alarm source.

Keywords—System Identification, Demand Side Management, Smart Home, Closed-loop control.

I. INTRODUCTION

Many home appliances and alarm systems still operate in open or pseudo-closed-loop control, which has a significant impact on the comfort and safety of people's lives. In addition, the electricity prices are determined by the load on the grid.

With the development of communication technology, some scholars have proposed the concept of the Smart Home - the use of network technology to connect all the apparatus in the home to work together, to achieve home automation, but also optimize the interaction between users and home apparatus. In addition, with the increase in people's demand for electricity and the existence of relatively fixed peak consumption, Demand Side Management (DSM) is proposed to shift the load and save energy costs.

In the past few years, system identification technology has been widely used in closed-loop control of various systems, including heating and cooling systems. But most of them are used in factories, cold storage, office buildings, and other large-scale scenarios. Yasaman Balali et al. have proposed a scheme to use system identification technology to model the internal thermal model of a building and use Model Predictive Control (MPC) and Reinforcement Learning (RL) to control the internal temperature of a building. However, this scheme is more suitable for large buildings with a central temperature control system, and the control scheme involved has high requirements on hardware computing ability, so it may not be suitable for temperature

control in an individual home. Therefore, it is highly desirable to design a simple temperature control system based on system identification which is suitable for small environments such as home interiors.

In this paper, we introduce a home control system that uses data-driven system identification methodologies to support developing closed-loop control over home apparatus. The control system also integrates Smart Home technology and Demand Side Management, facilitating collaborative functionality among home apparatus and enabling load shifting between the room heater and refrigerator. Additionally, it establishes connectivity between the home alarm and other home apparatus through the network. When it detects an alarm, it can automatically send a signal to other home apparatus and switch off the power supply of the home apparatus without manual operation. The structure of the control system is shown in Fig. 1. The system is simple to install, low cost, users do not need to replace the current home apparatus and only need to add additional control equipment to achieve the control effect.

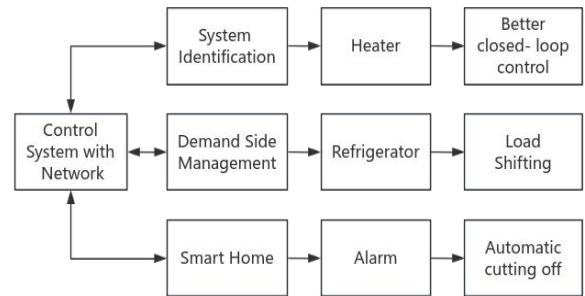

Fig. 1. Control system structure

II. SYSTEM IDENTIFICATION

To achieve better closed-loop control of the system, the system first needs to be modeled. In the case of an indoor heating system, for instance, the input to the system is the heating on and off, which is binary data, and the output of the system is the room temperature. Define the activation of heating as represented by '1' and deactivation as '0'. Transform the heating activation and deactivation into a square wave signal exhibiting amplitude values of 1 and 0 respectively, plotted against the horizontal axis of time. This resultant signal can serve as the input signal for the system. The output signal of the system is the trend of temperature changes over time. Since the temperature in the room is not equalized and there will be slight differences in temperature at different locations, the sensor is placed in the center of the

room and the temperature at that location is used as the average temperature of the room.

Data collection is achieved through the integration of computer software and Micro Control Unit (MCU) hardware working together. Initially, a data acquisition sub-system is developed to collect sensing data in a predefined format via the serial port and promptly exhibit the collected data on the Graphical User Interface (GUI) in real time. When the user gives the command to end the data collection, the application will automatically pack the collected data into MAT format to facilitate the subsequent procession of the data. The flowchart is shown in Fig. 2.

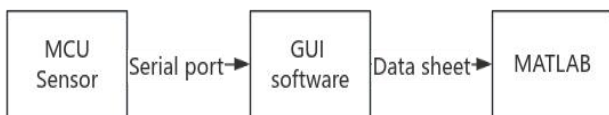

Fig. 2. Data collect process

The MCU is used to drive the temperature and humidity sensor for temperature data measurement. The MCU will drive the sensor to collect temperature data once every second and send the data to the computer through the serial port according to the specified format. The data collected is shown in Fig. 3.

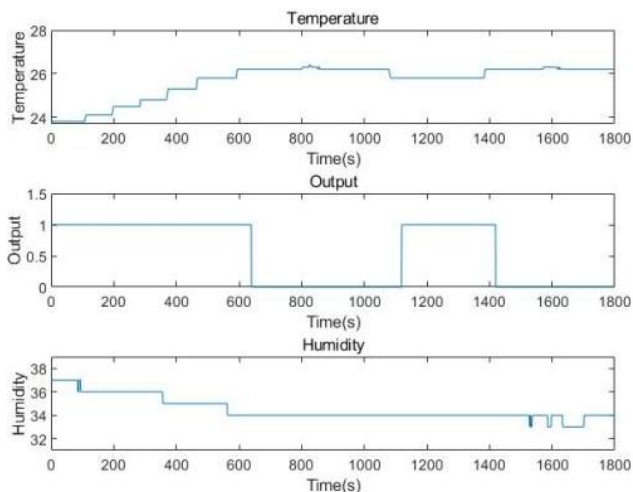

Fig. 3. Collected data from the sensor

Once the data has been collected, the room temperature needs to be recognized as a system based on the input and output data collected. Owing to the limited sensitivity of the sensor, the collected temperature data is a discrete signal. Then get the digital transfer function of the system by using the system identification technique according to the input and output data sheet, the transfer function is:

$$\frac{2.84 \cdot 10^{-5}}{1 - 1.99z^{-1} + 0.99z^{-2}} \quad (1)$$

The comparison of the measured temperature and the estimated via the transfer function model is shown in Fig. 4. The estimated temperature is more smooth than the measured one since the measured temperature has low sampling ratio and temperature between two samples are extended with simple zero order hold scheme.

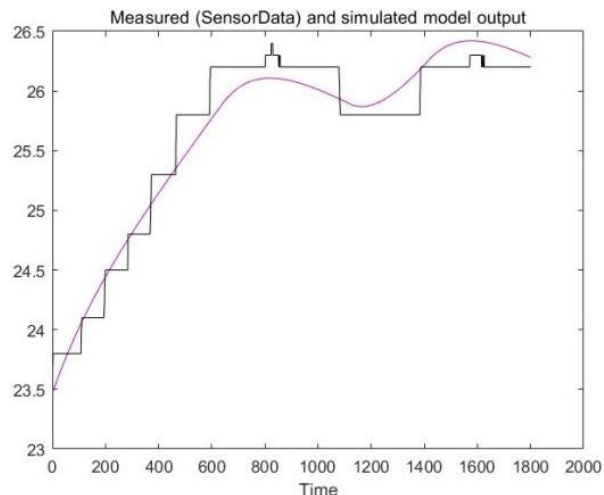

Fig. 4. Comparison between model and real

III. CONTROL SCHEME

A. Bang-bang control

PID controller is used to control the temperature. Since the heater is switched on and off as a binary signal with only two states, the continuous signal output from the PID controller needs to be converted into a binary signal that can be used to drive the switch of the heater. In this paper, the output signal of the PID controller is processed using Pulse Width Modulation (PWM). Take 10 minutes (600 seconds) as a control period, the continuous output signal from the PID controller is converted into a square wave signal with a period of 600 seconds. The duty cycle of this square wave signal is determined by the output signal from the PID controller. To prevent the damage to the heater caused by turning the heater on and off too frequently, a threshold range is added to the conversion between the output signal of the PID controller and the square wave signal that controls the heater switch. Only when the PID controller output signal is in the threshold range, it will be converted to a square wave signal. If the output signal of the PID controller is greater than the maximum value of the threshold range, the duty cycle of the generated square wave signal will be set to 100%, and if the output value of the PID controller is less than the minimum value of the threshold range, the duty cycle of the generated square wave signal will be set to 0%. As already mentioned in the system identification section, the amplitude 1 in the square wave signal means the heating is on, and 0 in the square wave signal means the heating is off. When the square wave signal is generated, the MCU will drive the actuator to control the heater switch according to the amplitude and duty cycle of the square wave signal (the falling edge of the signal turns off the heater, and the rising edge of the signal turns on the heater) to realize the closed-loop control of the heater.

The SIMULINK is employed for system simulation, evaluating the system's response upon setting the target temperature to 25 degrees Celsius in a room initially at 20 degrees Celsius. Following the application of the tuned PID controller to the simulated system, Fig. 5 illustrates the controller output and its corresponding control effects. It can be seen that the binary conversion of PID controller output using PWM is effective, and the entire temperature control is very stable. In the next step, the reference tracking ability and disturbance rejection ability of the controller will be further tested in the simulation environment.

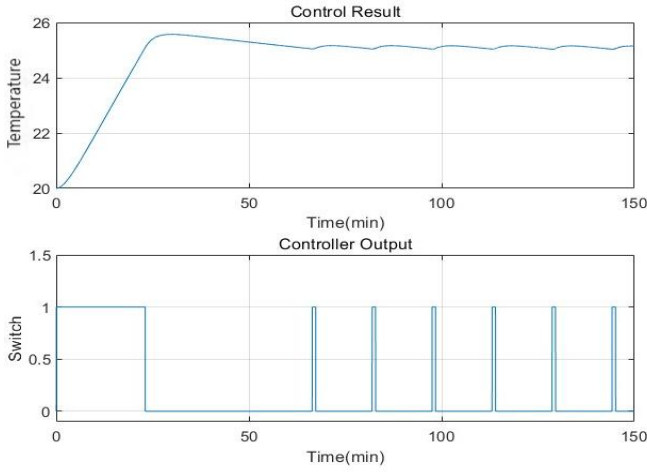

Fig. 5. Simulation of the control system

1) Reference tracking

The reference tracking ability of the controller is tested in the simulation environment. A square wave signal is generated as the reference signal of the temperature signal, and its amplitude is changed at different periods to simulate the changing of the target temperature. The response obtained in the simulation system is shown in Fig. 6. Adjust the target temperature to 26 degrees at the red marker, 28 degrees at the green marker, and 30 degrees at the orange marker. It can be seen that when the target temperature is higher than the current temperature, the controller can quickly make the temperature reach the target value. However, the controller can only control whether the switch of the heater is on or off and can not cool the room, so when the target temperature is lower than the current temperature, it can only rely on natural cooling to achieve the target value, and the controller can not control this process.

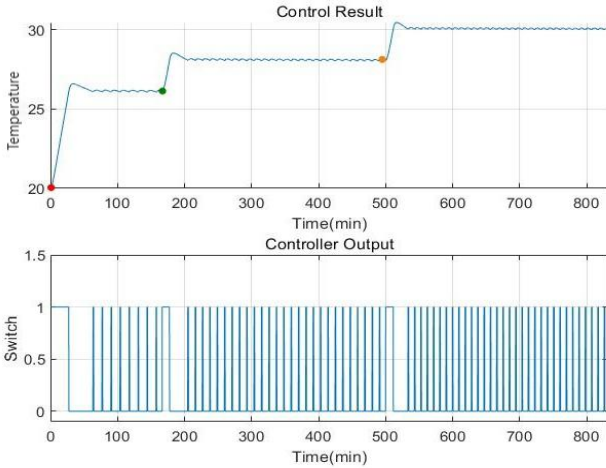

Fig. 6. Reference tracking ability

2) Disturbance rejection

The disturbance rejection ability of the controller is tested in the simulation environment. While keeping the reference signal unchanged, a random disturbance signal with an average value of 0 and a variance of 10 is added to the input of the system plant to simulate the disturbance factors that will affect the temperature in the real environment (such as window ventilation). The system response obtained is shown in Fig. 7. It can be seen that even if there is a certain degree

of disturbance in the environment, the controller can still maintain a good control effect, and the room temperature can remain relatively stable.

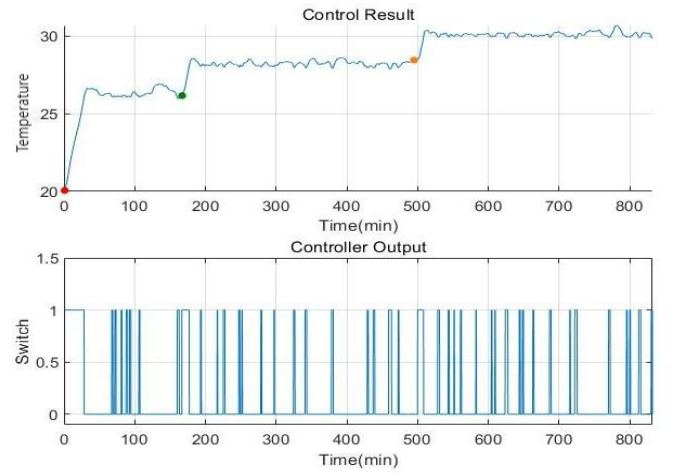

Fig. 7. Disturbance rejection ability

B. Load shifting

This aims to shift the load of the refrigerator. To realize the load shifting of the refrigerator, the refrigerator should be modeled first. Following the existing work from Stadler et al, the first order model is used which is given :

$$T_{i+1} = \epsilon * T_i + (1 - \epsilon) (T_{amb} - \frac{np}{A}) \quad (2)$$

where the ϵ defined as:

$$\epsilon = e^{-\frac{\tau A}{mc}} \quad (3)$$

where the T_i is the current temperature in the refrigerator, the T_{amb} is the current room temperature, n is the efficiency, p is the power of the compressor, A is the thermal conductivity, τ is the time step and mc is the thermal mass.

It is assumed that the heating control through the control system has stabilized the room temperature at 26 degrees Celsius. And set the initial temperature T_0 to 5 degrees Celsius. In addition, Stadler et al give a table of average data for other parameters which is shown in Table 1.

TABLE I. PARAMETER OF THE REFRIGERATOR MODEL

| Variable | Symbol | Value |
|----------------------|--------|-------|
| Efficiency | n | 3 |
| Thermal conductivity | A | 3.21 |
| Time step | τ | 30 |
| Thermal mass | mc | 86400 |

The MATLAB is used to model the temperature change based on the parameter above. According to the refrigerator operation manual, the compressor would start to work when the refrigerator temperature was higher than 8 degrees Celsius and stop working when it was lower than 4 degrees Celsius. Therefore, the temperature change of the refrigerator cold room in a day was obtained in the simulation environment, as shown in Fig. 8.

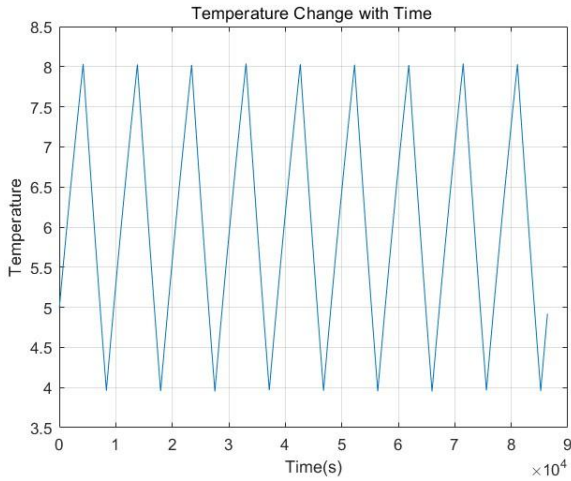

Fig. 8. The model of the refrigerator

Adjust the control scheme of the refrigerator. According to the control scheme proposed by Zaman et al., the compressor of the refrigerator will adjust the control state according to the changing trend of the electricity price.

- Activate the compressor if the current unit electricity price is decreasing.
- Deactivate the compressor if the unit electricity price is increasing.
- In case the current unit electricity price remains unchanged, assess the trend of the last unit electricity price. Activate the compressor if the price was decreasing; otherwise, deactivate it if the price was increasing.
- Regardless of the unit electricity price, activate the compressor if the temperature exceeds 8 degrees. Conversely, deactivate the compressor if the temperature falls below 4 degrees, regardless of the electricity price.

The algorithm is deployed in a simulation environment, and use a randomly generated array to simulate changes in unit electricity prices. After generating different unit electricity price for many times to test the control scheme, the data in Table 2 are obtained. It can be seen that the control scheme can effectively reduce the total electricity cost.

TABLE II. TEST RESULTS

| Test | Without controller | With controller |
|------|--------------------|-----------------|
| 1 | 0.129 | 0.114 |
| 2 | 0.128 | 0.115 |
| 3 | 0.130 | 0.113 |
| 4 | 0.127 | 0.111 |

In this process, the temperature change inside the refrigerator is shown in Fig. 9, it can be seen that the temperature inside the refrigerator has been maintained at a low state, and will not affect the normal operation of the refrigerator.

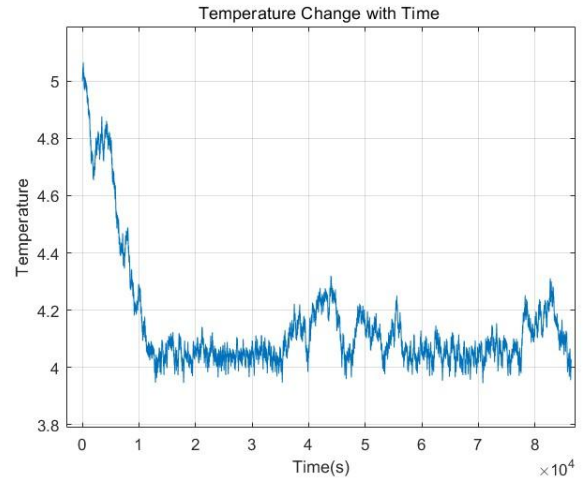

Fig. 9. The trend of the temperature

IV. HARDWARE IMPLEMENTATION

A. Hardware and software design

To make several home apparatus work together and achieve closed-loop control, the control system adopts a multi-device cooperation scheme, that is, each heater, refrigerator, and alarm are configured with a separate hardware controller. Different controllers can exchange data and work together. A single hardware controller uses the MCU as the main control chip, which can drive various sensors with peripheral circuits to measure the system, and can also run the digital PID algorithm for closed-loop control of home apparatus. So the MCU fully meets the performance requirements while the cost is very low. Therefore, rather than using a high-performance processor as the master controller to control each home apparatus, the use of multiple low-performance MCU hardware controllers can greatly reduce the system cost, which can greatly reduce the system cost. In addition, the multi-device cooperation scheme can greatly improve the scalability and adaptability of the control system. The layout of electrical appliances in different users' homes is different, and the electrical supply models are also different. With the multi-device cooperation scheme, the user does not need to change the layout and electrical supply models of the home apparatus but only needs to add a separate hardware controller to each home apparatus. Therefore, the control system can realize intelligent control without making any changes to the existing home apparatus and only needs to add one external hardware device, which greatly improves the scalability and adaptability of the system.

Multiple hardware controllers are connected together through WIFI to realize data transmission to work together. At the same time, users can also read the working status of each hardware controller and give instructions to the hardware controller through WIFI.

The chip used for the hardware controller needs to be able to connect to WIFI, drive the sensor, and run the PID controller algorithm at the same time. So the ESP8266 which is a MCU with network function is selected as the main control chip. The hardware controller for the heater needs to be able to collect the temperature data. Therefore, the DHT11 temperature and humidity sensor is used to obtain temperature data. The sensor of the hardware controller for the refrigerator needs to be able to achieve high-precision

data collection in a low-temperature environment. Ordinary sensors cannot work properly within the working temperature range of the refrigerator. So the temperature probe is selected for data collection. The mainstream home alarm will emit a buzzer after detecting an anomaly. So the hardware controller for the alarm is equipped with a microphone to detect the alarm sound to determine whether the current alarm is alarming. The structure of the entire control system is shown in Fig. 10.

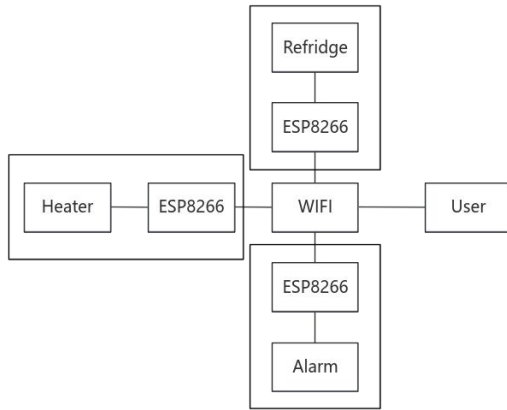

Fig. 10. Control system hardware structure

B. Heater control

This paper takes the control of push-button heating switch as an example. The ESP8266 is used for user interaction and PID controller implementation, the SG90 servo is used to press the button to turn on and off the heating, and the DHT11 sensor is used to realize real-time detection of temperature and humidity data. The SG90 servo is controlled by PWM signals, and its rotation angle is determined by the duty cycle of the square wave signal of a specific frequency received by its signal line. Therefore, it is only necessary to connect the signal line of the SG90 with the digital signal output IO port of the ESP8266, and connect the power line of the SG90 with the power output IO port of the ESP8266 to achieve the control of the SG90 servo using the ESP8266. The DHT11 uses digital signals to communicate with the MCU, so it only needs to connect its signal line with the ESP8266 digital signal output IO port, and connect its power cord with the ESP8266 power output IO port to collect temperature and humidity data. The overall hardware system is shown in Fig. 11.



Fig. 11. Heater control hardware structure

The ESP8266 is a MCU with network function, which is loaded with Bluetooth and network communication module. Therefore, the user can transmit data (such as target temperature) to the MCU through the network, and can also receive data from the MCU through the network (such as the current temperature). When the ESP8266 is started, its onboard network module allows the ESP8266 to join the user's home wireless network and obtain a unique LAN IP address. Users use mobile phones or computers to log in to the website with the IP address through a web browser to achieve data interaction with the ESP8266. Users can enter the desired target temperature, minimum humidity, and other parameters on the website, and transmit the data to the MCU.

Users can also check the current indoor temperature and humidity sent by the ESP8266 on the website, and how much time is left before the next control cycle.

After the system is built, the control effect is tested in the real world. First of all, test the effect of the PID controller. Set the target temperature to 25 degrees Celsius when the room temperature is 20 degrees Celsius. The actual control results are shown in Fig. 12. It can be seen that the system has a slight overshoot, but it can quickly reach a stable state. The overshoot phenomenon and steady state time are both very similar to the results of the simulation environment.

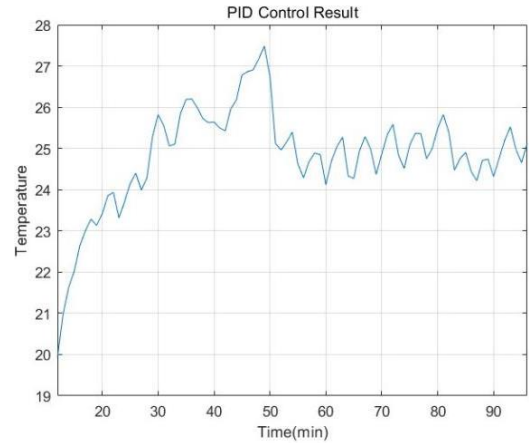

Fig. 12. PID control effort

The long-term control effect of the controller is tested. Collect data for 3 consecutive days, set the target temperature to 26 degrees Celsius, and the temperature trend chart as shown in Fig. 13 was obtained. Close the hardware controller for data comparison at the red marker and restart the hardware controller at the green marker. The window ventilation was opened to test the disturbance rejection ability of the controller, it is the period shown in orange in the figure. It can be seen that the controller can achieve a stable room temperature for a long time, but opening the window will cause a small steady-state error.

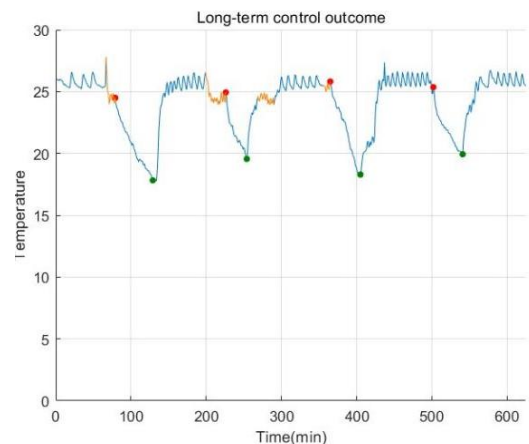

Fig. 13. Long-term control outcome

C. Fridge control

The hardware implementation of the refrigerator controller needs the price network interface from the power company. The ESP8266 is used as the main control chip, and the switch of the refrigerator compressor is driven by a relay. The hardware structure is shown in Fig. 14.

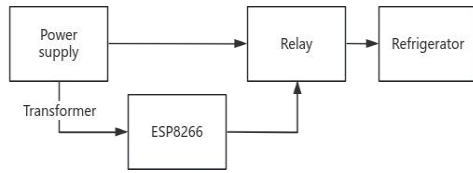

Fig. 14. Hardware structure of the refrigerator controller

To prevent the compressor from being damaged by too frequent switching, a control period of 10 minutes is stipulated, and the working state of the compressor does not change in a single working week. At the beginning of each control cycle, the ESP8266 adopts the request-response mode to obtain the current unit electricity rate (provided that the interface provided by the power company has been obtained), and compares the current unit electricity price with the unit electricity price obtained in the previous control cycle to determine whether the electricity price is rising or falling, and then drives the relay to control the compressor of the refrigerator. The software structure is shown in Fig. 15.

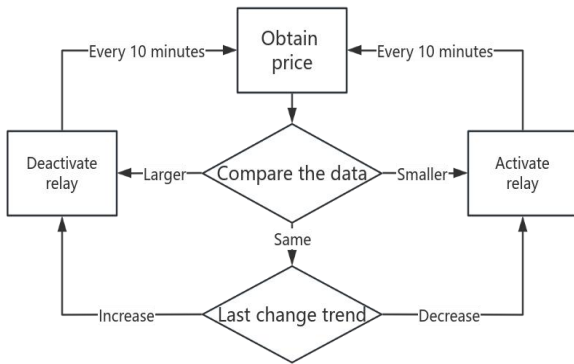

Fig. 15. The software structure of the refrigerator controller

D. Fire alarm protection control

The hardware controller of the alarm detects whether the alarm is alarming through the microphone, and controls the power switch or gas supply of the home apparatus through the relay. Because of the various sounds in the environment of the alarm, the hardware controller needs to distinguish the alarm sound from the normal noise. The audio signal of the alarm collected through the microphone is shown in Fig. 16.

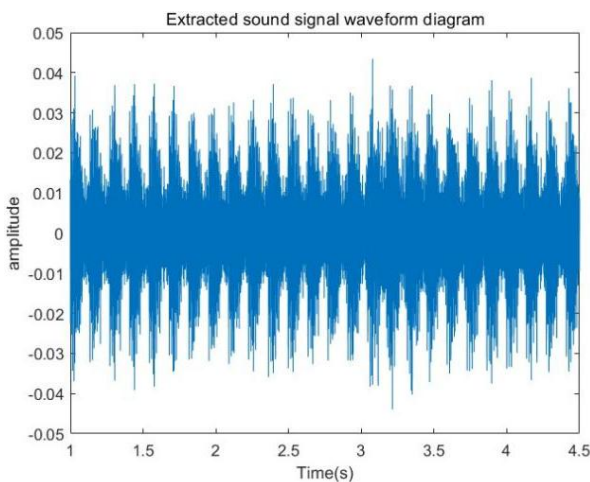

Fig. 16. Alarm sound signal

It can be seen that the alarm sound signal is a high-frequency oscillation signal with a certain period. Due to the limited performance of the MCU, it is impossible to analyze and process the received audio signal in the frequency domain, so it can only find out the special effects of the alarm signal in the time domain. It can be seen from the Figure 16 that the amplitude of the alarm signal changes approximately at a frequency of 8Hz. Therefore, it is only necessary for the MCU to sample the input signal of the microphone at a frequency of 16Hz for the sound signal, and detect whether the amplitude of the collected audio signal changes periodically, to detect whether the current alarm is alarming. The analog signal is sent to the specific pin of the MCU, and the MCU converts the received analog signal into a digital signal through the built-in Analog-to-Digital Converter (ADC) to realize the detection of the audio signal. The hardware structure is shown in Fig. 17.



Fig. 17. Hardware structure of alarm controller

V. CONCLUSION

This paper proposed a control system based on data-driven system identification for multiple home apparatus to control the room temperature better. It can reduce electricity bills by transferring the load to the refrigerator, and it connects the alarm to the control system so that it can automatically turn off the alarm source. After testing on both simulated and real-world home environment, the control system can effectively stabilize room temperature, reduce electricity bills, and successfully cut off power and gas when an alarm occurs. The proposed solution is effective for single sensor control, in other words, it can maintain the temperature near the sensor well. This could be sufficient for small room use such as bedroom. However, if the room space is big and with one heater radiator, then the temperature may not be as stable as the temperature near the sensor. Then, in this case, multiple radiators with multiple sensors, using MIMO control, will be desirable.

REFERENCES

- [1] Stadler, I. (2008). Power grid balancing of energy systems with high renewable energy penetration by demand response. *Utilities Policy*, 16(2):90–98.
- [2] Stadler, M., Krause, W., Sonnenschein, M., and Vogel, U. (2009). Modelling and evaluation of control schemes for enhancing load shift of electricity demand for cooling devices. *Environmental Modelling & Software*, 24(2):285–295.
- [3] Zaman, Anogh Utkalika and Doyle, James (2022). Smart Grid Control: Demand Side Management in Household Refrigerators as a tool for Load Shifting. *Macalester Journal of Physics and Astronomy: Vol. 10: Iss. 1*.
- [4] Balali, Y. et al. (2023). Energy modelling and control of building heating and cooling systems with data-driven and hybrid models—A review. *Renewable & sustainable energy reviews*, 183, pp.113496-.
- [5] Yang, C. (2021). Design of Smart Home Control System Based on Wireless Voice Sensor. *Journal of sensors*, 2021, pp.1–11.
- [6] Dawoud, D. Shenouda. and Dawoud, Peter. (2020). *Microcontroller and Smart Home Networks*. Aalborg: River Publishers.