



# Efficient identification of transient instability states of uncertain power systems

## Document Version

Accepted author manuscript

[Link to publication record in Manchester Research Explorer](#)

## Citation for published version (APA):

Papadopoulos, P., & Milanovic, J. V. (2017). Efficient identification of transient instability states of uncertain power systems. In *IREP 2017, X Bulk Power Systems Dynamics and Control Symposium*

## Published in:

IREP 2017, X Bulk Power Systems Dynamics and Control Symposium

## Citing this paper

Please note that where the full-text provided on Manchester Research Explorer is the Author Accepted Manuscript or Proof version this may differ from the final Published version. If citing, it is advised that you check and use the publisher's definitive version.

## General rights

Copyright and moral rights for the publications made accessible in the Research Explorer are retained by the authors and/or other copyright owners and it is a condition of accessing publications that users recognise and abide by the legal requirements associated with these rights.

## Takedown policy

If you believe that this document breaches copyright please refer to the University of Manchester's Takedown Procedures [<http://man.ac.uk/04Y6Bo>] or contact [openresearch@manchester.ac.uk](mailto:openresearch@manchester.ac.uk) providing relevant details, so we can investigate your claim.



# Efficient Identification of Transient Instability States of Uncertain Power Systems

Panagiotis N. Papadopoulos, *Member, IEEE*, Jovica V. Milanović, *Fellow, IEEE*

School of Electrical and Electronic Engineering, The University of Manchester  
Manchester, UK

[panagiotis.papadopoulos@manchester.ac.uk](mailto:panagiotis.papadopoulos@manchester.ac.uk), [milanovic@manchester.ac.uk](mailto:milanovic@manchester.ac.uk)

**Abstract**—This paper investigates the use of a game theoretic approach, namely the Monte Carlo Tree Search method, to identify critical scenarios considering transient stability of power systems. The method guides dynamic time domain simulations towards the cases that the system exhibits instability in order to explore efficiently the entire domain of possible operating conditions under uncertainty. Since the method focuses the search within the domain on the cases that are more probable to cause instability, information on stability boundaries and values of parameters critical for transient stability are also provided. Critical lines, penetration level of renewable energy sources and system loading can be defined this way.

**Keywords**—*game theory; monte carlo tree search, transient stability; uncertainty*

## I. INTRODUCTION

Various environmental, economic and technical reasons are causing changes in power system operation and dynamic behavior. The increasing penetration of Renewable Energy Sources (RES), which are in nature intermittent and exhibit different dynamic behavior, is one of the main reasons for this change. Apart from the direct impact caused by RES, the displacement of synchronous generation, either de-loading or disconnection, is also affecting significantly the power system dynamic behavior. Market operations dictating the conventional generation disconnection as well as changing the traditional behavior of loads (e.g. aggregators, storage devices, electric vehicles, etc.) are also affecting the pre-disturbance operating conditions.

Identifying and investigating the number of possible scenarios in order to study the power system dynamic behavior becomes more complicated with the increase in the number of uncertainties. This problem becomes more prominent especially in the cases when computationally intensive time domain simulations are required. Probabilistic Transient Stability Assessment (TSA) following either the conditional probability approach [1] or the Monte Carlo approach [2] have been proven to be an appropriate way to study the impact of uncertain parameters on transient stability. Direct methods such as [3] have been also used for probabilistic TSA offering additional information that can help identify weak areas of the system. However, they are generally not considered as accurate as methods based on time domain simulations [4]. More importantly, it is not easy to include the impact of RES with

their associated controllers [5].

Due to spatial and temporal uncertainties associated with RES operation, in particular, it is neither practical nor feasible to perform TSA based on “worst case scenarios”. Probabilistic methods are therefore used to assess various aspects of transient behaviour of power system with RES. Recently, the effect of wind generation uncertainty has been introduced in probabilistic TSA [6]-[8]. In [6] Monte Carlo time domain simulations are used for probabilistic TSA including wind uncertainty.

The number of the time domain Monte Carlo simulations required to achieve desired accuracy of assessment can increase substantially with the increase in number of uncertainties considered and the computational effort might become excessive, especially for large systems. Efficient sampling [7] and importance sampling methods [8] have been applied for the purpose of reducing the computational burden in probabilistic small-signal stability assessment, exhibiting very promising results.

In this paper a game theoretic approach is investigated to assess its feasibility to guide the Monte Carlo time-domain simulations towards the cases that cause transient instability, since these are the ones that are of interest. The Monte Carlo Tree Search (MCTS) algorithm is chosen which builds a search tree to explore the search space more effectively. The obtained search tree can be used to extract information on critical states of the system, irrespective of the shape of the underlying stability boundary.

## II. METHODOLOGY

### A. Monte Carlo Tree Search

In general, MCTS is a method for finding optimal decisions in a given domain by iteratively building a search tree and guiding the selection of nodes according to the results from the previous simulation. During the last several years it has been extensively applied for the solution of various games and also in other non-game domains, after the success it presented in simulating efficient decision making when applied to the challenging game of “Go” [9]. The procedure for applying MCTS method can be split in two main policies, namely the tree and default policy, as shown in Fig. 1. The method iteratively builds a search tree to explore the given search space, by choosing the most promising nodes according to a

---

This research was supported by the Engineering and Physical Sciences Research Council, UK, as a part of System Architecture Challenges: SuperGen+ for HubNet project (grant number: EP/N030028/1).

target, i.e., nodes causing instability in this application. The tree policy is responsible for choosing the most promising nodes and the default policy is afterwards applied to simulate the outcome of the “game”, i.e., a full detailed dynamic RMS type simulation in this application. The simulation result is finally back-propagated through the search tree until the values of associated nodes are updated.

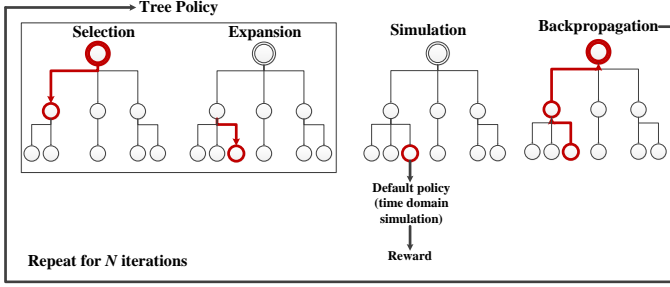

Fig. 1. Illustration of iterative procedure of MCTS method.

The tree policy (building the search tree) consists of the selection and expansion steps. During the tree policy a node from the existing tree is selected or a new leaf node is created. Starting from the root node of the tree, a node is selected based on a node selection policy.

In this paper, the upper confidence bound for trees (UCT) algorithm is chosen as the tree policy which balances the exploration and exploitation of the entire domain. The selection of nodes is treated as a multi-armed bandit problem, where the arm (child node in this case)  $j$  is chosen such that it maximizes the UCT value shown in (1).

$$UCT = \bar{X}_j + 2C_p \sqrt{\frac{2 \ln n}{n_j}} \quad (1)$$

where  $n$  is the number of times the current node (parent) has been visited,  $n_j$  is the number of times child  $j$  has been visited and  $C_p$  is a positive constant.

The first term  $\bar{X}_j$ , is the mean reward of the current (child) node, which should be within  $[0,1]$  and promotes the exploitation of most promising nodes, i.e. the nodes exhibiting instabilities in this case. The second term of (1) balances the exploration of the domain by increasing the UCT value of nodes that have not been explored extensively. For a previously unvisited child node, the value of  $n_j$  is zero and thus the value of UCT is infinite, ensuring that each child node will be visited at least once. As each (child) node is visited, the number  $n_j$  increases and therefore the value of the exploration term decreases. On the other hand, if a different child node of the current (parent) node is visited,  $n$  increases and therefore the exploration value of other children nodes of the same node increases. The exploration term therefore ensures that the probability of the selection of each child node is not zero. If for a given iteration the UCT value of different children nodes is equal, the tie is usually broken randomly.

The value of the constant  $C_p$  can be increased or decreased to adjust accordingly the exploration term. The value of  $1/\sqrt{2}$  is suggested by [10], which provides good results with rewards in the range  $[0, 1]$  as is the case in this paper.

Once a node is selected or added, the default policy is applied which consists of simulating the outcome of the game, usually by applying random moves until the end of the game. In this paper, the default policy consists of a dynamic time domain simulation and the outcome of the simulation is either 0 if the system is stable or 1 if it is unstable. Once the simulation is finished, the results are back-propagated through the tree to update the node values and rewards. Each node of the tree holds two values, the number of times each node has been visited and the reward value of each node. In the specific application in this paper, the reward is defined by  $N_u/N_s$ , where  $N_u$  is the number of unstable cases and  $N_s$  is the number of all simulated cases of the specific node.

MCTS offers the significant advantage that it does not require any domain-specific knowledge, i.e., in the case of the specific application for transient stability, there is no need to have any prior knowledge on where the stability boundary lies. This is an inherent advantage over previously used importance and efficient sampling methods [7], [8]. Moreover, the proposed method is not limited in terms of identifying the shape of the stability boundary, including stability boundaries with discontinuities (discrete nature), since it automatically favors the sampling of cases that lead to instability. For example, within an overall range of uncertain parameters (e.g. for a parameter varying from 0-50%) there might be some specific values only, sub-region, (e.g. 20-30%) that cause a certain generator (or generators) to operate close to the stability margin and consequently exhibit instability. (Note: Detailed comparison between MCTS and other importance/efficient sampling methods however, is out of the scope of this paper and it should be looked at in the future.)

MCTS is therefore used in this paper to sample efficiently the search space of possible operating conditions and disturbance scenarios, targeting cases that lead to transient instability. The obtained simulated scenarios are critical for power system stability studies in two main ways. First, they can be used to generate training databases for online dynamic security assessment (and furthermore, by defining the severity of the simulated scenarios the analysis can be extended to risk assessment). Secondly, the critical scenarios and parameters can be efficiently identified, including associated possible weaknesses in the system and actions (either preventive or corrective) that can be taken to improve system stability.

### B. Computational Burden Considerations

The two main constraints considering computational burden are related to time and memory restrictions. Memory can become a constraint when the search tree becomes very large. In this specific application presented below, memory does not introduce any practical constraint since the branching factor and the tree depth are not very large. Computational time on the other hand, might be a constraint, considering the time frame for the selected studies, though this depends to a large extent on the processor used (computational power available). If the assessment is performed for an hourly/daily/monthly/etc. period, and the available computational power is limited, the stopping criteria of MCTS algorithm should be adjusted accordingly. In this paper 10,000 iterations are performed, which corresponds to an error of the sample mean of less than

3% when random Monte Carlo is used (in a similar manner presented in [11]). Considering the specific study presented in this paper, the time required to complete 10,000 iterations (with simulations performed using DigSILENT/PowerFactory software) on a computer with Intel Core i7 3.4 GHz processor and 16 GB of RAM is approximately 70 hours.

### C. Application of MCTS on Power System Transient Stability Assessment

Due to the increased number of uncertain parameters in modern power system operation, a large number of possible cases need to be considered for system stability assessment. Computationally intensive time-domain simulations are considered an accurate solution considering transient stability assessment since they can represent, with sufficient accuracy, the related system dynamics and control actions. In this paper, the effect of three important parameters on transient stability is investigated to illustrate the feasibility of using MCTS method to efficiently assess transient stability of the uncertain power system.

The three parameters chosen in this study are fault location, RES penetration level and system loading. The choice of the specific parameters is based on the results of calculation of the uncertainty importance measure, using the Sobol method [12]. For this specific network and uncertain parameters, the three chosen layers are the three most important uncertain parameters. The fault duration is generally also one of the important parameters considering transient stability. In this study, however, the fault duration is considered to vary, following a normal distribution, within a (realistic) range of approximately 6 cycles (mean value of 14 cycles and standard deviation 6.67%) [11]. This range is not excessive to cause the fault duration to become significantly more important than other uncertainties. In any case, this does not affect the generality of the method, as in the most generic approach all the uncertain parameters could be represented by a dedicated layer. For the illustration purposes though, the number of layers was limited to three in this paper.

Each of these parameters is considered to have discrete values as shown in Table I. Consequently the search tree consists of three layers with fault location being the first layer, RES penetration the second and system loading the third. Therefore, the branches starting from the root node consist of cases where the fault is located on a specific line (1<sup>st</sup> layer). Similarly branches starting below the first and second layers correspond to cases where RES penetration and system loading, respectively, have certain values. Once a terminal node of the third layer is reached, a time domain dynamic simulation is performed considering also the uncertain behavior of each individual system load and each individual RES unit, as well as the fault duration and the fault location on the faulted line.

TABLE I. DISCRETE VALUES OF TREE NODES

TCs	Values	Number of values
<b>Fault location</b>	line {1...72}	72
<b>RES penetration</b>	0-50%/step 10%	6
<b>System loading</b>	60%-100%/step 10%	5

Three phase self-clearing faults on lines are considered in this study. A uniform distribution is used to model the fault location (on the specific line that has been chosen) which means that the fault may happen with equal probability at any point along the specific line, dictated by the tree node under which the simulation is currently performed. A normal distribution with mean value of 14 cycles and standard deviation 6.67% is used to model the fault duration [11].

From the discrete values of each node, the pu values for all the loads and all RES units are initially determined. The corresponding uncertainties are modeled afterwards as additional scaling factors following appropriate probability distribution functions (PDFs). For the loads a normal distribution is used [11], for the PV units a beta distribution [13] and for wind generators the uncertainty of the wind speed is modelled using a Weibull distribution [11], which is afterwards mapped to the power curve of a typical wind generator [14] to derive the power output. (Note: Any other distribution for fault location and duration as well as for modelling load and RES uncertainty could have been chosen without loss of generality.)

Therefore, the introduced uncertainty scaling factor for loads and RES units is eventually multiplied with the corresponding value from the respective node of the tree. The normal distribution for the system loading uncertainty has mean value 1 pu and standard deviation 3.33%, the beta distribution a and b parameters are 13.7 and 1.3 respectively and the Weibull distribution parameters used for wind generation are  $\varphi = 11.1$  and  $k=2.2$  [11]. The aforementioned PDFs are sampled separately for each load and RES unit in the system to represent the variability of the uncertainties in a more realistic manner.

After considering the uncertainties, OPF is solved to determine the output of conventional generators  $P_{SG,ig}$ . Conventional generation disconnection is also taken into account by assuming each power plant in the test system consists of four distinct generators. Each time the required power output of the power plant from the OPF solution is smaller than 25% of the initial nominal active power output of the power plant, the nominal capacity of each generator  $S_{SG,ig}$  is reduced by a fixed amount of 25% of the initial nominal generator power. This procedure reflects the synchronous generation disconnection by assuming that the generators with high cost (no other generator technical constraints nor system constraints were considered at this stage) will be switched off first.

## III. RESULTS

### A. Test Network

The test network used, is a modified version of the IEEE 68 bus/16 machine reduced order equivalent model of the New England Test System and the New York Power System (NETS – NYPS). The system consists of five areas, NETS, NYPS and three external areas represented by G14, G15 and G16 respectively. The conventional part of the test network is adopted from [15] and ten RES units are connected at the buses shown in Fig. 2. For each RES unit, two types of RES units are connected at each bus: Type 3 Doubly Fed Induction

Generators (DFIGs), representing wind generators and Type 4 Full Converter Connected (FCC) units, representing both wind generators and Photo-Voltaic (PV) units. The models used are available in DIgSILENT/PowerFactory [16] software and are suitable generic RMS models for large scale stability studies. All RES units are considered to provide Fault Ride Through (FRT) capability.

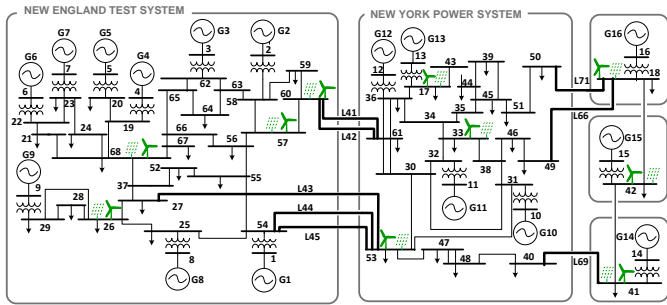

Fig. 2. Modified IEEE 68 bus test network.

### B. Overall Effectiveness of Proposed Method

The method is applied for 10,000 iterations and 67.48% of the simulated cases lead to instability (6748 unstable cases). This is a significant improvement with regards to approximately 10% of unstable cases reported in [11] (using random Monte Carlo) for the same test network and similar operating conditions and results in a more detailed sampling around the operating conditions that are critical and need to be investigated further. It also confirms the fact that the method does favor the nodes that tend to cause instabilities, following the selection and expansion process according to the UCT algorithm.

The resulting tree consists of 2160 leaf nodes (72 lines x 6 RES penetration levels x 5 system load levels). Each terminal node on the last layer is sampled a different number of times following the UCT algorithm, based on the balance of exploration and exploitation of the tree. The individual load and RES unit uncertainty, the fault duration and specific point of the fault on the line are the parameters that are varied between the simulations on a terminal leaf node.

In Fig. 3, the rewards (i.e. the percentage of unstable simulated cases) for each line of the system are presented. For the given system and studied operating conditions, there are some lines that do not lead to instability (0 reward) and others that have a reward close to 1 which means that a fault in that location is very possible to lead to instability and is therefore a critical location. Simulating faults on lines (and consequently visiting the respective tree nodes) with 0 reward does not offer additional information considering system stability. The computational efficiency increases if those nodes are not simulated (visited) often. The critical nodes are however, visited more often, providing more detailed sampling of the system states close to the stability boundary, as shown in Fig. 4.

In Fig. 5, a part of the tree (subtree) corresponding to a fault on critical line 1 (between bus 28 and 29) is presented. The node has been visited 2781 times and approximately 93% of those cases lead to instability. From previous studies on the

same network, generator G9 which is close to this line, has been found to exhibit a large number of instabilities as reported in [11]. The values inside each node correspond to the number of visits and the reward, respectively. The fault location, the RES penetration level and the system loading level are shown with red, green and blue color, respectively. By observing the reward values for different RES penetration levels (2<sup>nd</sup> layer), it can be concluded that the increasing RES penetration leads to lower number of unstable cases for this specific fault location. This effect is caused by the assumed FRT capability of RES units.

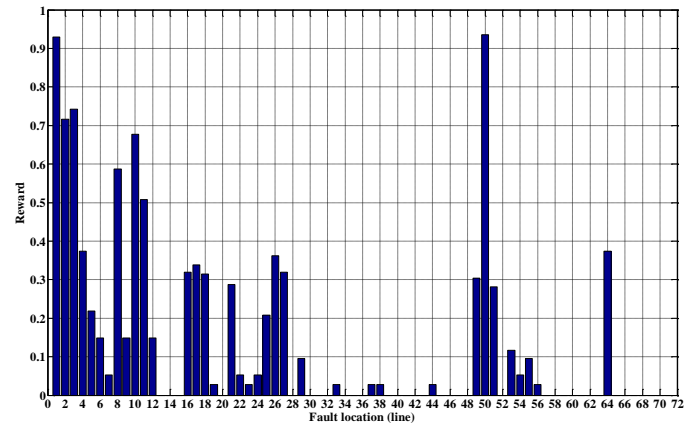

Fig. 3. Rewards of nodes corresponding to fault on different lines of the system (1<sup>st</sup> layer of search tree).

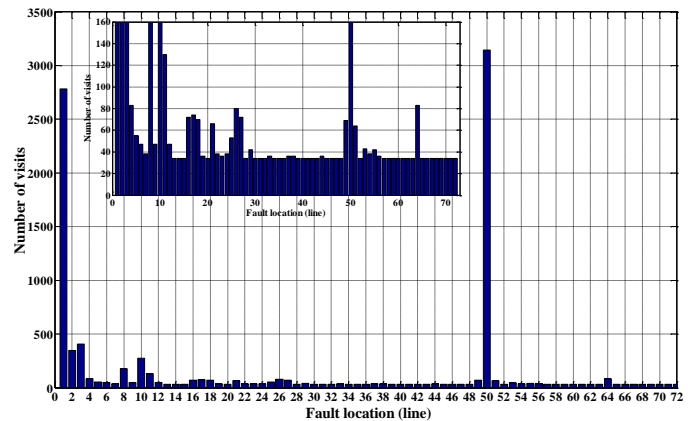

Fig. 4. Number of visits of nodes corresponding to fault on different lines of the system (1<sup>st</sup> layer of search tree).

### C. Critical Line Identification

When the number of iterations is complete, i.e. the tree search is built, there are two main parameters that can help in identifying the most promising nodes, which in this application correspond to the most critical nodes considering transient stability: looking for the node (child) with the highest reward and/or the most visited node (child) [9]. In this paper, the nodes are presented in a two dimensional plane with both their reward and number of times visited in order to identify the criticality of each node. The nodes exhibiting both high reward and a high number of visits are the most critical and tend to lead to a larger number of instabilities.



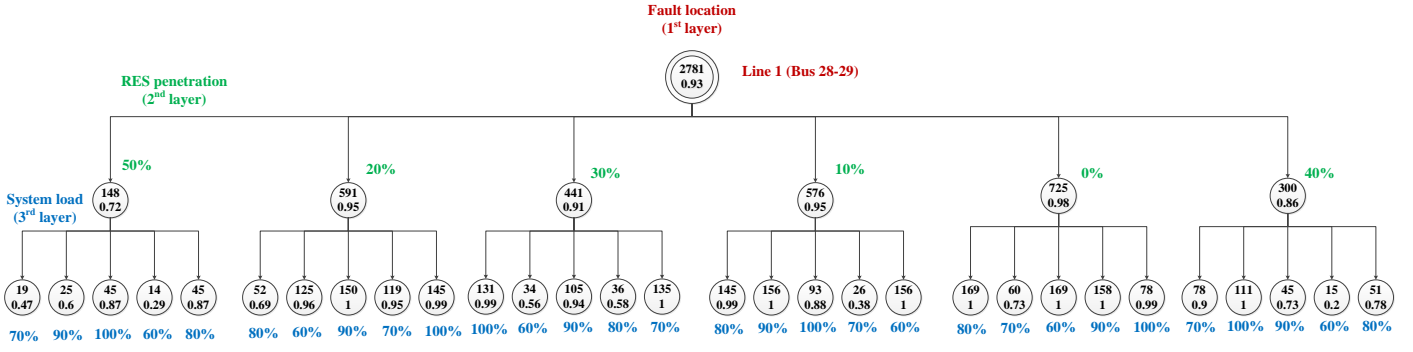

Fig. 5. Branch of search tree corresponding to fault on line 1.

In Fig. 6, the nodes of the first layer, i.e. corresponding to the line where the fault occurs, are presented. The number of the nodes of the first layer is 72, equal to the number of lines in the system under study. By observing the location of the nodes in Fig. 6, the lines can be categorized in groups according to how critical the fault location is. For this specific network and operating conditions investigated, three categories can be identified, e.g.  $\text{reward} > 0.9$ ,  $0.5 < \text{reward} < 0.9$  and  $\text{reward} < 0.5$ , corresponding to very critical lines, critical and less critical lines. While more sophisticated clustering algorithms can be applied to identify and group critical nodes (especially for networks with larger number of nodes), this remains out of the scope of this paper and will be explored as part of future research.

Lines 1 (between bus 28 and 29) and 50 (between bus 32 and 33) are identified as the most critical lines and have attracted a large number of simulations and therefore a detailed sampling of different possible operating conditions. Generators G9 and G11 are located close to those lines, having been identified as critical generators in [11]. It should also be mentioned that on Fig. 5, there is an overlap (not visible on the given graph) for several nodes with a zero reward which are the lines that did not exhibit any instabilities as also shown in Fig. 3. The number of times they have been visited is also the same revealing the way the search tree is built, and therefore the search space, is explored (equal opportunity to nodes with the same reward).

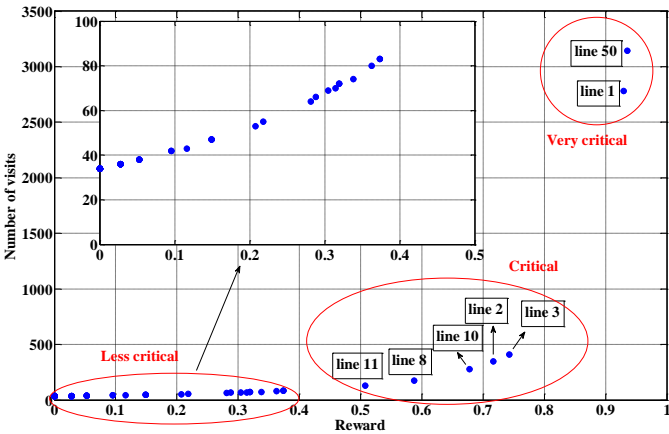

Fig. 6. Nodes of the search tree corresponding to fault location (1<sup>st</sup> layer).

#### D. Critical RES Penetration Level

In a similar manner, the nodes corresponding to the 2<sup>nd</sup> layer of the search tree (nodes corresponding to different RES penetration level) are presented in Fig. 7. There are 6 nodes corresponding to penetration levels from 0 to 50% for each one of the 72 nodes, of the previous layer (corresponding to the line where the fault is applied to). Therefore, there are  $72 \times 6 = 432$  nodes in total in the 2<sup>nd</sup> layer and similarly to the previous case there is an overlap for some of them on the figure, especially for nodes that have zero reward.

The nodes corresponding to the very critical lines (1 and 50) that have been identified previously are also marked within the red circle in Fig. 7 (12 nodes in total). As the penetration level increases, the nodes corresponding to those two critical lines move towards lower rewards and consequent number of visits. This indicates that the FRT capability of RES causes the specific lines to become less critical, as the penetration increases up to 50%. Moreover, a general trend with nodes corresponding to higher penetration levels presenting lower rewards and number of visits can be observed, for lines belonging also to the critical and less critical groups.

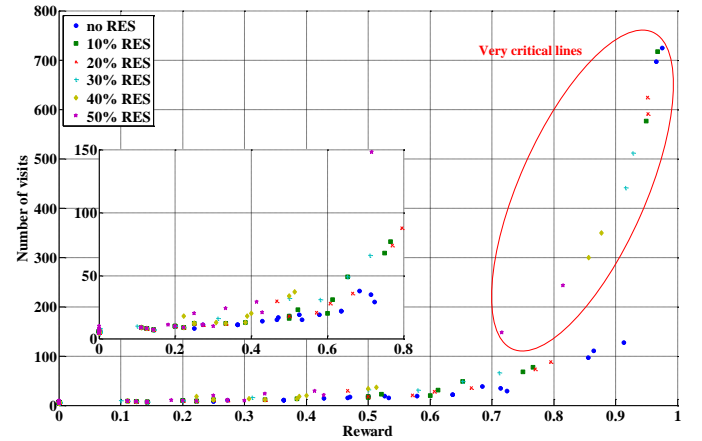

Fig. 7. Nodes of the search tree corresponding to RES penetration level (2<sup>nd</sup> layer).

#### E. Critical System Loading Values

In Fig. 8, the leaf nodes of the search tree corresponding to different system loading are presented. The total number of nodes is 2160 (72 lines  $\times$  6 RES penetration levels  $\times$  5 system load levels) and as previously described there is an overlap of nodes in this case also, especially for nodes with zero reward.

A group of nodes with reward 1 and relatively low number of simulations is also observed (overlapping occurs for different loading levels similar to the case of nodes with zero reward mentioned above), indicating that they might have not been yet explored adequately. This can be attributed to the UCT algorithm choosing more promising nodes from previous layers (e.g. corresponding to a more promising line) that eventually lead to the exploitation of overall more promising nodes. However, given enough computation time (and consequently iterations) nodes like the ones described above would eventually be explored better due to the fact that the UCT algorithm balances between exploration and exploitation of the tree, as explained in Section II A.

While in general, higher loading level nodes tend to have higher rewards and number of visits, this tendency is not observed in all of the nodes presented in Fig. 8, highlighting the importance of using the proposed method to identify critical scenarios. A traditional approach assuming for example maximum system loading or minimum loading and maximum penetration are worst case scenarios, might mask cases when certain generators are stressed. This for example might happen due to the effect of economic dispatch (OPF solution followed in this paper) causing some generators to operate more heavily loaded under certain conditions.

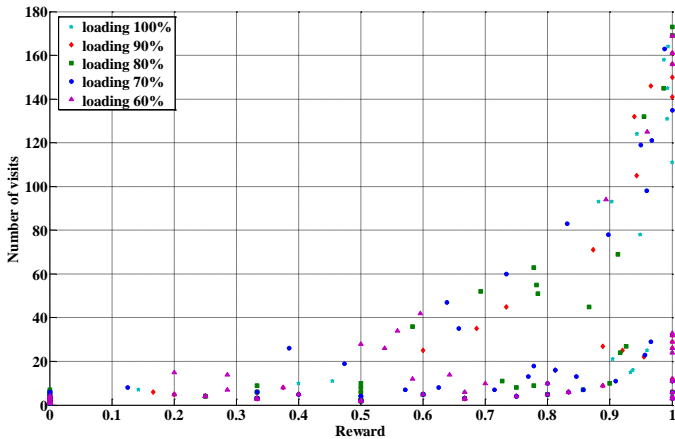

Fig. 8. Nodes of the search tree corresponding to different system loading level (3<sup>rd</sup> layer – leaf nodes).

#### F. Detailed Queries to Identify Critical Parameters under Specific Conditions

An example of more detailed queries that can be performed once the construction of the search tree is finished, is provided in Fig. 9. Specific tree nodes, corresponding to faults on Line 50 (one of the critical lines identified above), for high system loading (100%) and low system loading (60%) for various penetration levels (0-50%) are presented. For 100% system loading, nodes corresponding to higher level of RES penetration tend to become slightly less critical (due to assumed FRT capability of RES). Similarly, for low system loading, the cases without RES and with high penetration level of RES (40% and 50%) become less critical. However, for relatively small RES penetration (10%-30%), low system loading can lead to critical operating conditions, possibly due to initiating disconnection of conventional generation. It should be mentioned here, that disconnection of conventional

generation is assumed to occur in this specific study in discrete steps (25% of generator nominal apparent power), as described in Section II C. Distinct operating conditions that might cause some generators to operate closer to the stability limit can be identified this way.

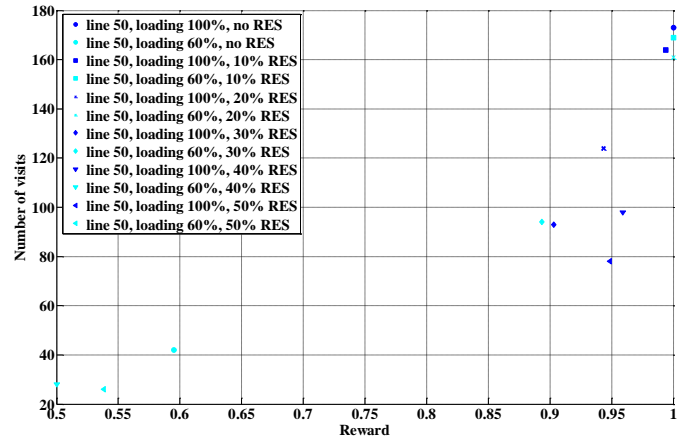

Fig. 9. Nodes of the search tree corresponding to low/high system loading for all RES penetration levels and for faults on line 50.

#### IV. CONCLUSIONS

An initial implementation of MCTS method to guide time domain simulations towards the unstable region(s) of power systems considering transient stability are presented in this paper. Three parameters with discrete values, namely fault location, RES penetration level and system loading level, are used to represent the search domain. Initial results show that the method causes a biased sampling of the search domain towards the cases that tend to exhibit unstable behavior, increasing the efficiency of performed simulations.

Furthermore, distinct operating conditions and fault locations that might lead to instability can be identified by carrying out queries on the obtained search tree. The proposed method is particularly useful in identifying critical states that might lead to instability even in the case that there is no prior knowledge of where the stability limit lies, which is the case in modern power systems with increased uncertainties.

#### ACKNOWLEDGEMENT

This research was supported by the Engineering and Physical Sciences Research Council, UK, as a part of System Architecture Challenges: Supergen+ for HubNet project (grant number: EP/N030028/1).

#### REFERENCES

- [1] R. Billinton, P.R.S. Kuruganty, "Probabilistic Assessment of Transient Stability in a Practical Multimachine System," in *IEEE Trans. Power Apparatus and Systems*, vol.PAS-100, no.7, pp.3634-3641, July 1981.
- [2] P.M. Anderson, A. Bose, "A Probabilistic Approach to Power System Stability Analysis," in *IEEE Trans. Power Apparatus and Systems*, vol.PAS-102, no.8, pp.2430-2439, Aug. 1983.
- [3] M. Abapour and M. R. Haghifam, "On-line assessment of the transient instability risk," in *IET Generation, Transmission & Distribution*, vol. 7, no. 6, pp. 602-612, June 2013.

- [4] J. Geeganage, U. D. Annakkage, T. Weekes and B. A. Archer, "Application of Energy-Based Power System Features for Dynamic Security Assessment," in *IEEE Transactions on Power Systems*, vol. 30, no. 4, pp. 1957-1965, July 2015.
- [5] K. Hua, A. Vahidnia, Y. Mishra and G. Ledwich, "Efficient probabilistic contingency analysis through a stability measure considering wind perturbation," in *IET Generation, Transmission & Distribution*, vol. 10, no. 4, pp. 897-905, 3 10 2016.
- [6] S. O. Faried, R. Billinton and S. Aboreshaid, "Probabilistic evaluation of transient stability of a power system incorporating wind farms," in *IET Renewable Power Generation*, vol. 4, no. 4, pp. 299-307, July 2010.
- [7] R. Preece, K. Huang and J. V. Milanović, "Probabilistic Small-Disturbance Stability Assessment of Uncertain Power Systems Using Efficient Estimation Methods," *IEEE Trans. Power Syst.*, vol. 29, no. 5, pp. 2509-2517, Sept. 2014.
- [8] R. Preece and J. V. Milanović, "Efficient Estimation of the Probability of Small-Disturbance Instability of Large Uncertain Power Systems," *IEEE Trans. Power Syst.*, vol. 31, no. 2, pp. 1063-1072, March 2016.
- [9] C. B. Browne *et al.*, "A Survey of Monte Carlo Tree Search Methods," *IEEE Trans. Computational Intelligence and AI in Games*, vol. 4, no. 1, pp. 1-43, March 2012.
- [10] L. Kocsis, C. Szepesvári, and J. Willemson, "Improved Monte-Carlo search," Univ. Tartu, Tartu, Estonia, Tech. Rep. 1, 2006.
- [11] P. N. Papadopoulos, J. V. Milanovic, "Probabilistic Framework for Transient Stability Assessment of Power Systems with High Penetration of Renewable Generation," *IEEE Trans. Power Syst.*, available online.
- [12] K. N. Hasan, R. Preece, J. V. Milanovic, "Priority Ranking of Critical Uncertainties Affecting Small-Disturbance Stability Using Sensitivity Analysis Techniques," *IEEE Trans. Power Syst.*, 2017, available online.
- [13] M. Fan, V. Vittal, G. Heydt, R. Ayyanar, "Probabilistic power flow studies for transmission systems with photovoltaic generation using cumulants," *IEEE Trans. Power Syst.*, vol.27, no.4, pp.2251-2261, 2012.
- [14] Vestas Americas Inc., "V80-2.0 MW: Unsurpassed reliability and performance at high-wind sites in North America," [Online]. Available: [www.vestas.com](http://www.vestas.com).
- [15] G. Rogers, *Power System Oscillations*. Kluwer Academic, 2000.
- [16] DIgSILENT-PowerFactory User Manual, DIgSILENT GmbH, 2014.
- [17] Wind turbines - Part 27-1: Electrical simulation models - Wind turbines, IEC 61400-27-1, 2015.